

## ***Oil Drain Valves***

THE CLEANEST SOLUTION FOR CHANGING FLUIDS



## TABLE OF CONTENTS

|                                     |    |
|-------------------------------------|----|
| <u>About Femco</u> .....            | 3  |
| <u>Application List (A-Z)</u> ..... | 4  |
| <u>Femco Standard Plug</u> .....    | 12 |
| <u>Femco Compact Plug</u> .....     | 20 |
| <u>Femco Click Drain Plug</u> ..... | 26 |
| <u>Femco Non-Drip Plug</u> .....    | 31 |
| <u>Femco XL Plug</u> .....          | 34 |
| <u>Plugs for EV's</u> .....         | 35 |
| <u>Special Parts</u> .....          | 36 |

### United States Office:

Femco USA Inc.  
 22722 29th Dr SE, Suite 100  
 Bothell WA 98021  
 United States  
 +1 425 318 6050  
 +1 800 340 2147  
 [usa@femco.com](mailto:usa@femco.com)

### European Office:

Femco Drain Technology B.V  
 Rendementsweg 7  
 3641 SK Mijdrecht  
 The Netherlands  
 +31 (0)297 – 23 02 05  
 [info@femco.com](mailto:info@femco.com)

## Femco® Draintechnology

Femco® Draintechnology is home of the original quick connect drain plug. Since 1983, we have designed and manufactured our products in-house at our facility in The Netherlands. Our commitment to clients has enabled us to deliver exceptional products, with the innovation and development that has been key to making Femco an industry standard.

Femco's systems bring enhanced efficiency, safety, and cleanliness to equipment maintenance. With over 600 unique sizes, we always have a suitable solution. Femco drain plugs are versatile and can be used for various liquids, including but not limited to engine oil, hydraulic fluid, gearbox oil, and coolant. Femco also offers oil drain valves for fuel tanks.

### What are the advantages of the Femco® drainage system?

- Reduced downtime during service.
- The ability to safely drain oil at operating temperature.
- Waste oil is contained from oil pan to container, eliminating risk of spills.
- Eliminates the risk of stripped threads.
- No heavy wrench necessary, all you need is the drain hose.
- Eliminates risk of environmental pollution during field or mobile service.

This catalog includes an application guide for common truck, bus, automotive, industrial, and agricultural engines, along with a lineup of Femco's standard product offerings.

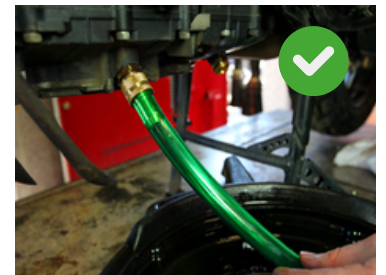

If you want more information please feel free to contact us.



**Faster  
Oil Change**



**Safer  
Oil Change**



**Easy  
To Use**

# Application list (A-Z)

Below is an application guide covering common engines, their OEM drain plug thread pitch, and compatible Femco part numbers.

**Can't find your size?** Our website features a more comprehensive search engine with more engines and equipment. Visit [www.femco.com](http://www.femco.com) or scan the QR code:



## CASE-IH

| Application   | Thread Size       | LB/SB | Standard   | Click Drain | Compact    |
|---|-------------------|-------|------------|-------------|------------|
| NPT Plugs   | 1-11.5-NPT-T12    | LB    | 6060020145 | 8060020516  | 7060020413 |
| 9250-9280, 9350-9390  | 1-18-UNS-T12      | LB    | 6060020148 | 8060020519  | 7050020417 |
| 3304 , 3508 , Some 3306   | 1 1/2-12-UNF-T12  | LB    | 6080020128 | 8080020496  | 7080020355 |
| STX Tractors w/Cummins QSX  | M27x2.0-T12       | LB    | 6090020070 | 8090020458  | 7090020216 |
| Acert C27 (Driver, Rear, pass. Front)   | 1 5/16-12-UNF-T12 | LB    | 6080020125 | 8080020494  | 7080020372 |
| C4.4, 3054, 3056, 3204<br>Plug on side: C7, C9, 3116, 3126  | 3/4-16-UNF-T10    | LB    | 6080020113 | 8080020481  | 7080020358 |
| 305, 359, 504.5, 505CID, MAGNUM SERIES,<br>5120-9240 w/ Cummins 5.9, 8.3L<br>Plug on bottom: C7, C9, 3116, 3126   | M18x1.5-T14       | LB    | 6090020037 | 8090020477  | 7090020183 |
| 3176 , 3412 , 3406 , 3408 , some 3306<br>C10, C11, C12, C13, C15, C16, C18<br>Acert C27 (Pass. Rear, Driver Front)  | 1 1/8-12-UNF-T15  | LB    | 6080020123 | 8080020491  | 7080020387 |
| <b>OEM:</b> 688067C1, 445097, 41300HA,<br>359875R1, 445096<br>D282, D312, D360, D407, D414, D436, DT407,<br>DT414, DT429, DT436, DT466, V800<br><b>Case-IH Combine:</b> 1440, 1460, 1480 Case-IH<br><b>Cotton Picker:</b> 1822, 1844 Case-IH<br><b>Industrial/Construction:</b> 2656, 2706, 2856,<br>21026, 21256, 21456<br><b>Case IH-Tractor:</b> 100, 130, 140, 154, 230, 240,<br>275, 330, 340, 350, 354, 384, 400, 404, 414,<br>424, 434, 444, 450, 454, 460, 464, 504, 544,<br>560, 574, 600, 606, 650, 656, 660, 666, 674,<br>686, 706, 756, 766, 806, 826, 856, 886, 966,<br>986, 1066, 1026, 1086, 1206, 1256, 1456,<br>1466, 1486, 1566, 1586, 2400, 2404, 2424,<br>2444, 2500, 2606, 3388, 3414, 3444, 3488,<br>3588, 3688, 3788, 4100, 4156, 4366, 4386,<br>4568, 4586, 4786, 5088, 5288, 5488, 6388,<br>6588, 6788, TD5, Early 500 | 7/8-18-UNF-T10    | LB    | 6080020118 | 8080020486  | 7080020363 |

# Application list (A-Z)

## CATERPILLAR

| Application   | Thread Size        | LB/SB | Standard   | Click Drain | Compact    |
|---|--------------------|-------|------------|-------------|------------|
| CT11-15   | M27x2.0-T12        | LB    | 6090020070 | 8090020458  | 7090020216 |
| CAT745C   | 1-11-BSP-T12       | LB    | 6070020141 | 8080020506  | 7070020401 |
| KT1150, QSKT19, KTTA19  | 1 1/16-12-UNF-T15  | LB    | 6080020122 | 8080020490  | 7080020386 |
| 3054, 3056, 3204, 3208, 4.4L  | 3/4-16-UNF-T10     | LB    | 6080020113 | 8080020481  | 7080020358 |
| Fuel Tank: 793F, 777G, 994H   | 1 1/16"-12-UNF-T27 | LB    |            | 8080020490R |            |
| All CAT's with tapered pipe plug  | 1-11.5-NPT-T12     | LB    | 6060020145 | 8060020516  | 7060020413 |
| 936, 950, 3304, 3508, 3306(some), 3044C   | 1 1/2-12-UNF-T12   | LB    | 6080020128 | 8080020496  | 7080020355 |
| 3116, 3126, 3126B, C4, C7, C9 (plug on the bottom)  | M18x1.5-T14        | LB    | 6090020037 | 8090020477  | 7090020183 |
| 299D, 299D XHP, 300.9D, 3011C, 3013C, 3014, 3024, 3024C, 303.5, 303E, 304E2, 305E2, C1.1, C1.5, C1.6, C1.7, C2.2, C22, CH3XL2.22TIC, XQ20   | M16x1.5-T10        | LB    | 6090020036 | 8090020426  | 7090020184 |
| 3176, 3406, 3408, 3412, C10, C11, C12, C13, C14, C15, C16, C18, C27, C30, 3306 (some)<br>OEM #: 9X6451  | 1 1/8-12-UNF-T15   | LB    | 6080020123 | 8080020491  | 7080020387 |
| 1100, 1140, 1145, 1150, 1160, 24H, 24M, 308E2, 3100, 3114, 3116, 3126, 3126B (oil drain plug on side), 3126E, 3208, 430F, 446, 446B, 446D, 65C, 65E, 69D, 725, 725C, 730, 730, 730C, 730C, 75C, 75D, 75E, 85C, 85D, 85E, 924K, 930K, 938, 938K, 95E, BH, C-6, C-7, C-9, CX31-C9I, MTC735, R2900, TH31-E61 | 3/4-16-UNF-T15     | LB    | 6080020114 | 8080020482  | 7080020359 |

## CHEVROLET

| Application  | Thread Size    | LB/SB    | Standard                 | Click Drain | Compact                  |
|--|----------------|----------|--------------------------|-------------|--------------------------|
| C10, C20, C30, C1500, C2500, C3500, G10, G20, G30, K10, K20, K30, K1500, K2500, K3500, R0, R10, R30, R1500, R2500, R3500<br>Most older Chevy/GMCars trucks | 1/2-20-UNF-T12 | SB<br>LB | 6080010085<br>6080020136 | 8080020512  | 7080010332<br>7080020392 |
| Most 1990 and newer Chevy/GM cars & trucks<br>Duramax Diesel (2017+)   | M12x1.75-T9    | SB       | 6090010004               |             | 7090010153               |
| Duramax Diesel (2001-2016)   | M14x1.5-T12    | SB       | 6090010021               |             | 7090010155               |

# Application list (A-Z)

## CUMMINS

| Application  | Thread Size        | LB/SB    | Standard                 | Click Drain              | Compact                  |
|--|--------------------|----------|--------------------------|--------------------------|--------------------------|
| X12  | M22x1.5-T10 (8/4)  | LB       | 6090020047               | 8090020436               |                          |
| QSK 23   | M28x1.5-T12        | LB       | 6090020075               | 8090020464               | 7090020339               |
| QSK45, QSK60   | M42x2.0-T12        | LB       | 6090020090               | 8090020469               | -                        |
| A2000, A2300   | M14x1.5-T10        | LB       | 6090020033               | 8090020423               | 7090020181               |
| QSK, VT504, 555, 378V6   | 3/4-16-UNF-T10     | LB       | 6080020113               | 8080020481               | 7080020358               |
| KT1150, KTTA19, QSKT19   | 1 1/16-12-UNF-T15  | LB       | 6080020122               | 8080020490               | 7080020386               |
| 1995-2002 Dodge 5.9L Diesel  | M22x1.5-T15        | SB<br>LB | 6090010026<br>6090020049 | 8090010441<br>8090020440 | 7090010174<br>7090020198 |
| ISX, ISZ13, X15<br>OEM: 4926565, 3680534   | M27x2.0-T12 o-ring | LB       | 6090020071               | 8090020459               |                          |
| QSX, QST30, N15, X15, Sig. 600   | M27x2.0-T12        | LB       | 6090020070               | 8090020458               | 7090020216               |
| B6.7<br>Other 6.7L Diesel, 3.3L, 4.5, QSB (side port)<br>(Some: ISB, ISC, ISL, QSL, 6B, 6C)  | M22x1.5-T10        | SB<br>LB | 6090010023<br>6090020046 | 8090010436<br>8090020436 | 7090010172<br>7090020195 |
| ISM, L10, M11, N14, NH, NT, NTC, QSM,<br>QSK50, 350NT, 444, 855<br>OEM: 3055069  | 1-18-UNS-T12       | LB       | 6060020148               | 8060020519               | 7050020417               |
| 5.9L CPL2071, 8.3L<br>(Most ISB, ISC, ISL, QSL 6B, 6C, ISLG, ISQ, QSC,<br>B&C Series, 4BT3.9, 6BT5.9, 8.3L, 355)<br>Pre 1995 Dodge 5.9L Diesel<br>2003-2006 Dodge 5.9L Diesel, Dodge 6.7L<br>Diesel, QSB (bottom plug) | M18x1.5-T14        | LB       | 6090020037               | 8090020477               | 7090020183               |

## DETROIT DIESEL

| Application   | Thread Size    | LB/SB    | Standard                 | Click Drain              | Compact                  |
|---|----------------|----------|--------------------------|--------------------------|--------------------------|
| 30 Series   | M14x1.25-T10   | LB       | 6090020032               | 8090020422               | -                        |
| 40 Series   | M25x1.5-T15    | LB       | 6090020061               | 8090020451               | 7090020210               |
| DD5, DD8  | M22x1.5-T10    | LB       | 6090020046               | 8090020436               | 7090020195               |
| 50 & 60 Series, 352, 353, 453, 652, 853                         | 3/4-14-NPT-T15 | LB       | 6060020144               | 8060020520               | 7060020411               |
| DD13, DD15, DD16, V8, V12<br>2000, 4000 Series                  | M27x2.0-T12    | LB       | 6090020070               | 8090020458               | 7090020216               |
| 6V92, 6V71, 8V92, 8V71, 471T<br>53, 71, 92, Other Small Engines | 1/2-14-NPT-T12 | SB<br>LB | 6060010109<br>6060020143 | 8060010514<br>8060020513 | 7060010354<br>7060020408 |

# Application list (A-Z)

## DODGE

| Application  | Thread Size    | LB/SB | Standard   | Click Drain | Compact    |
|--|----------------|-------|------------|-------------|------------|
| All 3.9L, 5.2L, 5.9L, 8.0L, 8.1L, 8.3L<br>Pre1999 2.7L, 3.2L, 3.3L, 3.5L, 3.8L                           | 1/2-20-UNF-T10 | LB    | 6080020109 | 8080020477  | 7080020354 |
| All 1.7L, 1.8L, 2.0L, 2.4L, 2.6L, 3.0L, 3.6L, 3.7L,<br>5.7L, 6.1L<br>1999 + 2.7L, 3.2L, 3.3L, 3.5L, 3.8L | M14x1.5-T10    | LB    | 6090020033 | 8090020423  | 7090020181 |
| Cummins 5.9L Diesel Pre 1995<br>Cummins 5.9L Diesel 2003-2006<br>Cummins 6.7L Diesel                     | M18x1.5-T14    | LB    | 6090020037 | 8090020477  | 7090020183 |
| Cummins 5.9L Diesel 1995-2002  | M22X1.5-T15    | LB    | 6090020049 | 8090020440  | 7090020198 |

## FORD

| Application  | Thread Size    | LB/SB | Standard   | Click Drain | Compact    |
|--|----------------|-------|------------|-------------|------------|
| Replacement standard yellow OEM plug<br>OEM: BC3Z-6730-A / FT4Z-6730-A / KX6Z-<br>6730-B<br>Certain Ford trucks from 2015-2021<br>Ford Mustang<br>Ford Edge SUVs | Ford Special   | LB    | 6420001    | 8040020009  | -          |
| Powerstroke 6.0L, 6.4L, 6.7L, 7.3L   | M14x1.25-T10   | LB    | 6090020032 | 8090020422  | 7090020180 |
| Ford 7.3L (extended collar)<br>Ford 6.8L gas V8 2023+ (extended collar)  | M12x1.75-T12   | LB    | 6090020130 | 8090020412  |            |
| 1991+ 5.4L, 1993+ 5.8L<br>1997-2010: 5.0L, 7.5L, V10-6.8L  | M14x1.5-T10    | LB    | 6090020033 | 8090020423  | 7090020181 |
| Pre 1997 5.0L, Pre1993 5.8L<br>1987-1994 7.3L Diesel   | 1/2-20-UNF-T10 | LB    | 6080020109 | 8080020477  | 7080020354 |
| Duratec 24 valve 3.0L & 3.5L<br>1996 + 4.2L, 1996 -2003 2.3L<br>2.5L SOHC. 1995 + V6-2.5L, 2011 +5.0L  | M12x1.75-T9    | SB    | 6090010004 |             | 7090010153 |

# Application list (A-Z)

## HINO

| Application  | Thread Size | LB/SB | Standard   | Click Drain | Compact    |
|--|-------------|-------|------------|-------------|------------|
| EC100, H06C, H07C, W04C                              | M22x1.5-T10 | LB    | 6090020046 | 8090020436  | 7090020195 |
| DS50, EL100, EM100, EP100, E13C                      | M30x1.5-T10 | LB    | 6090020074 | 8090020463  | 7090020220 |
| F17D, F20C, F21C, J05C, J08C, J08E, K13C, S05D, W04D | M18x1.5-T14 | LB    | 6090020037 | 8090020477  | 7090020183 |

## INTERNATIONAL

| Application   | Thread Size    | LB/SB | Standard   | Click Drain | Compact    |
|---|----------------|-------|------------|-------------|------------|
| S13   | M26x2.0-T10    | LB    | 6090020063 | 8090020452  |            |
| S13 with external oil hose drain assembly   | 1/2-14-NPT-T12 | LB    | 6060020143 | 8060020513  | 7060020408 |
| MaxxFace 11, 13, 15   | M27x2.0-T12    | LB    | 6090020070 | 8090020458  | 7090020216 |
| 152, 187, 304, 345, 392, 360  | 1/2-20-UNF-T10 | LB    | 6080020109 | 8080020477  | 7080020354 |
| VT275, VT365, T444E, MaxxFace 5 & 7   | M14x1.25-T10   | LB    | 6090020032 | 8090020422  | 7090020180 |
| 2006-2009 w/Vin < 2 million DT466 & DT570<br>MaxxFace 10 Bottom plug  | M18x1.5-T14    | LB    | 6090020037 | 8090020477  | 7090020183 |
| 404, 420 (6.9L), 461, 462, 478, 537, 549, 550,<br>986, 1086, 1486, 1466, D150, D170, D190<br>Pre 1995: 466, 551, DT366, DT466, 7.3L | 7/8-18-UNF-T10 | LB    | 6080020118 | 8080020486  | 7080020363 |
| MaxxFace DT, 9, 10 Side plug<br>DT360, DT408, DT530<br>1995-2003 DT466 & DT570<br>2004-2006 & 2006 w/Vin > 2 million DT466 & DT570  | M25x1.5-T15    | LB    | 6090020061 | 8090020451  | 7090020210 |

## ISUZU

| Application  | Thread Size | LB/SB | Standard   | Click Drain | Compact    |
|--|-------------|-------|------------|-------------|------------|
| 4BE1, 4BG2, 4JA1, 4JB1, 4ZC1, C223, C200   | M14x1.5-T10 | LB    | 6090020033 | 8090020423  | 7090020181 |
| 3LB1, 3LD1, 4BC1, 4BC2, 4BD1&2, 4HE1, 4JC1,<br>4JC2, 4JG2, 4HK1, 4LE1, 6BB1, 6BD1T, 6BF1,<br>6BG1, 6HK1, 6HF1, 6WG1, B Series, BA1,<br>C240, G161, HE1, Tier 2 | M20x1.5-T10 | LB    | 6090020040 | 8090020430  | 7090020189 |
| 4HK1, 4JJ1, 4L2X DH10H, 6BF1, 6QA1&2, 6RA1,<br>6RB1, 6SA1&2, 6SB1, 8PA1, 8PB1, 8PC1,<br>10PA1, 10PB2 OPC1, 10PE1, 12PB1, 12PC1,<br>DA220, DA640, E120, Tier3   | M24x2.0-T12 | LB    | 6090020057 | 8090020447  | 7090020206 |



# Application list (A-Z)

## JOHN DEERE (Parts & Engines)

| Application   | Thread Size       | LB/SB    | Standard                 | Click Drain              | Compact                  |
|---|-------------------|----------|--------------------------|--------------------------|--------------------------|
| Part# T111565   | M16x1.5-T10       | LB       | 6090020036               | 8090020426               | 7090020184               |
| Part# RE 46685, R27474  | M18x1.5-T14       | LB       | 6090020037               | 8090020477               | 7090020183               |
| Part # 15H623<br>100 Series, 20 Engine GU20374  | 3/8-18-NPT-T10    | SB       | 6060010107               |                          | 7060010352               |
| Part# R26727<br>359+, 404, 466, 619, 850, 955CID  | 1-14-UNF-T12      | LB       | 6080020121               | 8080020489               | 7080020367               |
| Part# RE523251, RE46687, R515195,<br>R116102, RE500611, RE507950<br>5G, 50G, 60G, 75G, 85G<br>3029 (Oil Pan #1909), 4045 (Oil Pan #1944),<br>6068 (Oil Pan #1944), 4022, 4990, 5045D,<br>7130, 7330 | M22x1.5-T10       | SB<br>LB | 6090010023<br>6090020046 | 8090010436<br>8090020436 | 7090010172<br>7090020195 |
| With 855 or L10 Cummins   | 1-18-UNS-T12      | LB       | 6060020148               | 8060020519               | 7050020417               |
| 4045 (All, except oil pan # 1944), 6068 (All,<br>except oil pan # 1944), 4045T<br>160, 643L, 834J, 843K, 843L, JD-EX, JD-EX 160   | M18x1.5-T10       | LB       | 6090020037               | 8090020477               | 7090020183               |
| Part# T20098<br><b>AG TRACTORS:</b> 301-401, 820-830, 1020, 1070,<br>1520-1530, 2020-30, 2150, 2240-50, 2440,<br>2630-40, 6100, 6200, 6300, 6400, 6500  | 7/8-20-UNF-T10    | LB       | 6080020119               | 8080020487               | 7080020364               |
| Part# R27175, R39741, R84262<br>496CID, 4050-4055 SERIES<br><b>AG TRACTORS:</b> 4755-4960, 7200, 7400, 7600,<br>7700-7710, 7800-7810, 8100-8420, 8430(new),<br>9100-9520                            | 1 1/16-12-UNF-T15 | LB       | 6080020122               | 8080020490               | 7080020386               |
| Part# M1746T<br>359CID<br><b>AG TRACTORS:</b> 2010, 2040, 2350-55, 2550-<br>55, 2750-2955, 3050-3255, 4030  | 7/8-14-UNF-T10    | LB       | 6080020115               | 8080020483               | 7080020360               |
| <b>AG TRACTORS:</b> 3010-3020, 4000-4020, 4230-<br>4240, 4430-4440, 4620-4630   | 1-14-UNF-T12      | LB       | 6080020121               | 8080020489               | 7080020367               |
| <b>Part # 15H623</b><br><b>100 Series, 20 Engine GU20374</b><br><b>AG TRACTORS:</b> 105, PC9540   | 3/8-18-NPT-T10    | LB       | 6060020142               | 8060020512               | 7060020407               |
| <b>AG TRACTORS:</b> 7.310   | M27x2.0-T12       | LB       | 6090020070               | 8090020458               | 7090020216               |

# Application list (A-Z)

## KOMATSU

| Application   | Thread Size    | LB/SB | Standard   | Click Drain | Compact    |
|---|----------------|-------|------------|-------------|------------|
| WA500-3   | 1-11.5-NPT-T12 | LB    | 6060020145 | 8060020516  | 7060020413 |
| With Perkins  | 3/4-16-UNF-T10 | LB    | 6080020113 | 8080020481  | 7080020358 |
| 3D72, 3D72-2BA (SN#1001-3000), 3D75, 3D75N, 3D78, 3D78N, 3D80, 3D84, 3D84N, 4D84  | M22x1.5-T10    | LB    | 6090020046 | 8090020436  | 7090020195 |
| 1D75, 1D84, 2D68E, 2D75, 3D62AE, 3D63, 3D66, 3D68E, 3D72N, 3D78-1F, 3D84, 3D84E, 3D84N-2AA, KDP20T, KDP30T, KDP40T, S3D84, S3D84E | M24x1.5-T15    | LB    | 6090020055 | 8090020445  | 7090020204 |

## MACK

| Application              | Thread Size    | LB/SB    | Standard                 | Click Drain              | Compact                  |
|--------------------------|----------------|----------|--------------------------|--------------------------|--------------------------|
| E9                       | 1/2-14-NPT-T12 | SB<br>LB | 6060010109<br>6060020143 | 8060010514<br>8060020513 | 7060010354<br>7060020408 |
| E3, EC3, EC5, E6         | 7/8-14-UNF-T10 | LB       | 6080020115               | 8080020483               | 7080020360               |
| ASET, E7, CHC, 350       | M20x1.5-T10    | LB       | 6090020040               | 8090020430               | 7090020189               |
| MP7, MP8, MP10, Midliner | M24x1.5-T15    | LB       | 6090020055               | 8090020445               | 7090020204               |
| M200, M250, CS200, CS250 | M36x2.0-T12    | LB       | 6090020082               | 8090020471               | 7090020337               |

## MERCEDES

| Application   | Thread Size       | LB/SB    | Standard                 | Click Drain              | Compact                  |
|---|-------------------|----------|--------------------------|--------------------------|--------------------------|
| Atego   | M24x1.5-T12       | LB       | 6090020054               | 8090020444               | 7090020203               |
| Actros  | M20x1.5-T15       | LB       | 6090020044               | 8090020432               | -                        |
| OM502LA   | M20x1.5-T10       | LB       | 6090020040               | 8090020430               | 7090020189               |
| Up to 2005 MBE 4000 (S/N<833529)  | M26x1.5-T10 (47L) | LB       | 6090020066               | -                        | -                        |
| OM441LA, OM457HLA, OM906HLA, OM457LA<br>Older Trucks & Bus engines        | M26x1.5-T10       | LB       | 6090020063               | 8090020452               | 7090020212               |
| MBE 4000 (S/N> 833529), MBE 900/906,<br>OM 460, 926                       | M22x1.5-T10       | SB<br>LB | 6090010023<br>6090020046 | 8090010436<br>8090020436 | 7090010172<br>7090020195 |
| OM612DE27LA, OM611DELA euro2,<br>OM642DE30LA, OM651DE22LA,<br>OM646DE22LA | M14x1.5-T10       | LB       | 6090020033               | 8090020423               | 7090020181               |

## Application list (A-Z)

### PACCAR

| Application          | Thread Size      | LB/SB | Standard   | Click Drain | Compact    |
|----------------------|------------------|-------|------------|-------------|------------|
| MX (2015 and older)  | M26x1.5-T10      | LB    | 6090020063 | 8090020452  | 7090020212 |
| MX 11, MX 13 (2016+) | COP Special Plug | -     | -          | 8040020001  | -          |
| PX6, PX7, PX8, PX9   | M18x1.5-T14      | LB    | 6090020037 | 8090020477  | 7090020183 |

### VOLVO

| Application  | Thread Size    | LB/SB | Standard   | Click Drain | Compact    |
|--|----------------|-------|------------|-------------|------------|
| FH16   | M24x2.0-T12    | LB    | 6090020057 | 8090020447  | 7090020206 |
| Grader   | M32x1.5-T12    | LB    | 6090020078 | 8090020467  | 7090020222 |
| TD Models, Penta, F6, F7, F86, N10.12                                  | 7/8-14-UNF-T10 | LB    | 6080020115 | 8080020483  | 7080020360 |
| D7, D11, D11A, D11C, D12, D13, D13A, D13C, D16, D16C, D16C7, F12, FH12 | M24x1.5-T15    | LB    | 6090020055 | 8090020445  | 7090020204 |

**Can't find your size?** Our website features a search engine with more engines/equipment. Visit [www.femco.com](http://www.femco.com) or scan the QR code:



# Femco Standard Plug



In 1983 Femco® introduced the Standard plug to make routine oil changes a quick, clean, and more environmentally friendly process.

The Standard plug is machined from solid brass, a durable, corrosion resistant metal, not prone to conducting heat.

The oil drain plug features a dust cover and a two O-ring's, protecting the valve assembly and ensuring reliable performance in the most demanding conditions. There is no need to use heavy wrenches or keys with our plugs.

## How it works:

Install the Femco standard plug in your engines oil pan. When it's time for an oil change, simply unscrew the dust cap and screw on the Femco drain hose. The action of screwing the hose on opens the internal valve, allowing the waste oil to drain. The drain hose allows for the waste oil to be drained directly into a container for disposal.

## When should you choose the Standard plug?

- The Standard plug is perfect for gravity drain applications.
- For larger drain ports (22mm and above), the Standard LB plug is the best fit (such as heavy equipment and trucks)
- For smaller drain ports, the Standard SB plug is the best fit (such as cars and small/medium equipment).

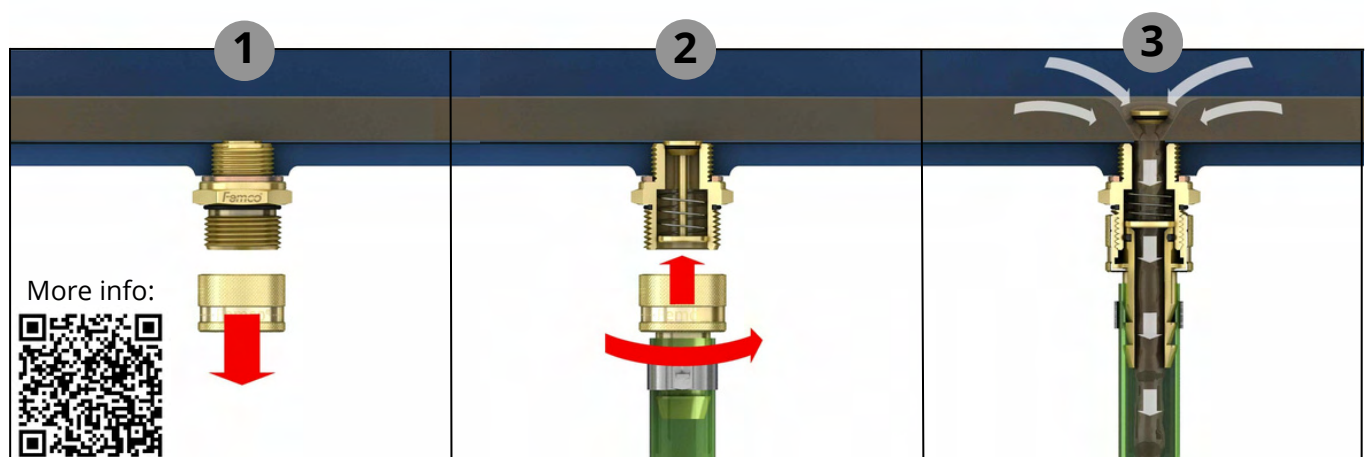

# Femco Standard Plug LB (Large Bore)

## Product Specifications



### Metric sizes

| Thread size      | Item number   | T  | A  | B  | S      | Hex |
|------------------|---------------|----|----|----|--------|-----|
| M12x1.25         | 6090020029    | 10 | 32 | 30 | 2      | 30  |
| M12x1.5          | 6090020030    | 10 | 32 | 30 | 2      | 30  |
| M12x1.75         | 6090020031    | 10 | 32 | 30 | 2      | 30  |
| M14x1.25         | 6090020032    | 10 | 32 | 30 | 2      | 30  |
| M14x1.5          | 6090020033    | 10 | 32 | 30 | 2      | 30  |
| M16x1.5          | 6090020036    | 10 | 32 | 30 | 2      | 27  |
| M18x1.5          | 6090020037    | 14 | 28 | 30 | 2      | 30  |
| M18x1.5          | 6090020038    | 10 | 32 | 30 | 2      | 30  |
| M18x1.5          | 6090020039    | 15 | 32 | 30 | 2      | 30  |
| M20x1.5          | 6090020040    | 10 | 32 | 30 | 2      | 30  |
| M20x1.5          | 6090020044    | 15 | 32 | 30 | 2      | 30  |
| M22x1.5          | 6090020046    | 10 | 32 | 30 | 2      | 30  |
| M22x1.5 8/4      | 6090020047    | 10 | 32 | 30 | 2      | 30  |
| M22x1.5          | 6090020047-01 | 12 | 32 | 30 | 2      | 27  |
| M22x1.5          | 6090020050    | 17 | 30 | 30 | 2      | 30  |
| M22x1.5          | 6090020049    | 15 | 32 | 30 | 2      | 30  |
| M24x1.5          | 6090020053    | 10 | 32 | 30 | 2      | 30  |
| M24x1.5          | 6090020054    | 12 | 30 | 30 | 2      | 30  |
| M24x1.5          | 6090020055    | 15 | 28 | 30 | 2      | 30  |
| M24x2.0          | 6090020057    | 12 | 30 | 30 | 2      | 30  |
| M24x2.0          | 6090020058    | 21 | 30 | 30 | 2      | 30  |
| M25x1.5          | 6090020061    | 15 | 27 | 30 | 2      | 32  |
| M26x1.5          | 6090020063    | 10 | 32 | 30 | 2      | 32  |
| M26x1.5          | 6090020066    | 10 | 42 | 30 | 2      | 32  |
| M26x1.5          | 6090020064    | 17 | 25 | 30 | 2      | 32  |
| M26x1.75         | 6090020067    | 10 | 32 | 30 | 2      | 32  |
| M27x2.0          | 6090020070    | 12 | 30 | 30 | 2      | 32  |
| M27x2.0 + o-ring | 6090020071    | 12 | 30 | 30 | o-ring | 32  |
| M28x1.5          | 6090020076    | 12 | 30 | 30 | 2      | 36  |
| M30x1.5          | 6090020074    | 10 | 32 | 30 | 2      | 36  |
| M32x1.5          | 6090020078    | 12 | 30 | 30 | 2      | 36  |
| M36x1.5          | 6090020081    | 12 | 30 | 30 | 2      | 42  |
| M36x2.0          | 6090020082    | 12 | 30 | 30 | 2      | 42  |
| M38x2.0          | 6090020083    | 12 | 32 | 30 | 2      | 46  |
| M42x2.0          | 6090020090    | 12 | 30 | 30 | 2      | 50  |

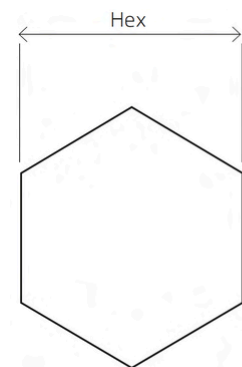
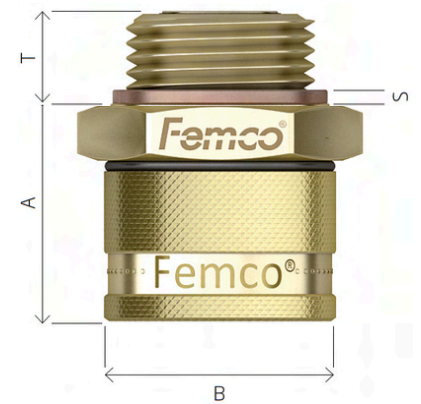

# Femco Standard Plug LB (Large Bore)

## Product Specifications



### NPT sizes

| Thread size | Item number | T  | A  | B  | S   | Hex |
|-------------|-------------|----|----|----|-----|-----|
| 3/8-18 NPT  | 6060020142  | 10 | 32 | 30 | n/a | 30  |
| 3/4-14 NPT  | 6060020140  | 12 | 30 | 30 | n/a | 32  |
| 3/4-14 NPT  | 6060020144  | 15 | 27 | 30 | n/a | 32  |
| 1/2-14 NPT  | 6060020143  | 12 | 30 | 30 | n/a | 30  |
| 1-11.5 NPT  | 6060020145  | 12 | 30 | 30 | n/a | 36  |

### UNF sizes

| Thread size            | Item number | T  | A  | B  | S | Hex |
|------------------------|-------------|----|----|----|---|-----|
| 1/2-20 UNF             | 6080020109  | 10 | 32 | 30 | 2 | 30  |
| 1/2-20 UNF             | 6080020136  | 12 | 30 | 30 | 2 | 30  |
| 3/4-16 UNF             | 6080020113  | 10 | 32 | 30 | 2 | 30  |
| 3/4-16 UNF             | 6080020114  | 15 | 32 | 30 | 2 | 30  |
| 7/8-14 UNF             | 6080020115  | 10 | 32 | 30 | 2 | 30  |
| 7/8-18 UNF             | 6080020118  | 10 | 32 | 30 | 2 | 30  |
| 7/8-20 UNF             | 6080020119  | 10 | 32 | 30 | 2 | 30  |
| 1-14 UNF               | 6080020121  | 12 | 30 | 30 | 2 | 32  |
| 1 1/16-12 UNF          | 6080020122  | 15 | 27 | 30 | 2 | 32  |
| 1 1/16-12 UNF + O-ring | 6080020132  | 15 | 27 | 30 | 2 | 32  |
| 1 1/16-12 UNF          | 6080020131  | 25 | 27 | 30 | 2 | 32  |
| 1 1/8-12 UNF           | 6080020123  | 15 | 27 | 30 | 2 | 36  |
| 1 1/8-12-UNF           | 6080020124  | 12 | 30 | 30 | 2 | 36  |
| 1 5/16-12 UNF          | 6080020125  | 12 | 30 | 30 | 2 | 36  |
| 1 5/16-12 UNF          | 6080020126  | 15 | 27 | 30 | 2 | 36  |
| 1 1/2-12 UNF           | 6080020128  | 12 | 30 | 30 | 2 | 46  |

### BSP sizes

| Thread size  | Item number | T  | A  | B  | S | Hex |
|--------------|-------------|----|----|----|---|-----|
| 1/4-19 BSP   | 6070020130  | 10 | 32 | 30 | 2 | 30  |
| 3/8-19 BSP   | 6070020131  | 10 | 32 | 30 | 2 | 30  |
| 1/2-14 BSP   | 6070020132  | 10 | 32 | 30 | 2 | 30  |
| 3/4-14 BSP   | 6070020134  | 10 | 32 | 30 | 2 | 32  |
| 1-11 BSP     | 6070020141  | 12 | 30 | 30 | 2 | 36  |
| 1 1/2-11 BSP | 6070020144  | 10 | 30 | 30 | 2 | 55  |

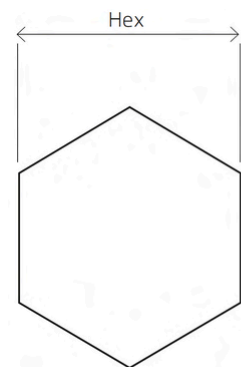
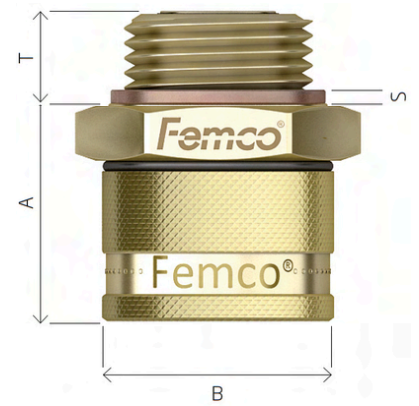

# Femco Standard Plug LB (Large Bore)

## Product Specifications



### Special sizes

| Thread size                          | Item number | T  | A  | B  | S | Hex |
|--------------------------------------|-------------|----|----|----|---|-----|
| Special Fit - Hose end               | 6090020087  | 15 | 27 | 30 | 0 | 30  |
|                                      |             |    |    |    |   |     |
| M12x1.75 - With extended body        | 6090020130  | 12 | 58 | 30 | 2 | 30  |
|                                      |             |    |    |    |   |     |
| Special Fit - Ford composite oil pan | 6040020001  |    |    |    |   |     |

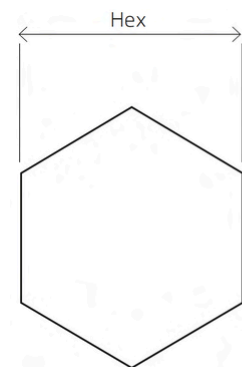
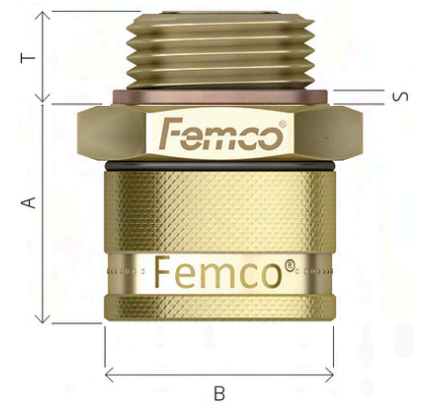

# Femco Standard Plug SB (Small Bore)

## Product Specifications



### Metric sizes

| Thread size | Item number | T  | A  | B  | S   | Hex |
|-------------|-------------|----|----|----|-----|-----|
| M12x1.25    | 6090010002  | 9  | 27 | 25 | 2   | 22  |
| M12x1.5     | 6090010003  | 9  | 27 | 25 | 2   | 22  |
| M12x1.75    | 6090010004  | 9  | 27 | 25 | 2   | 22  |
| M14x1.25    | 6090010005  | 9  | 27 | 25 | 2   | 22  |
| M14x1.5     | 6090010007  | 9  | 27 | 25 | 2   | 22  |
| M16x1.5     | 6090010012  | 9  | 27 | 25 | 2   | 22  |
| M16x1.5     | 6090010029  | 10 | 32 | 25 | 2   | 22  |
| M16x1.5     | 6090010013  | 12 | 25 | 25 | 2   | 27  |
| M18x1.5     | 6090010015  | 12 | 25 | 25 | 2   | 24  |
| M18x1.5     | 6090010027  | 14 | 27 | 25 | 2   | 24  |
| M20x1.5     | 6090010018  | 10 | 27 | 25 | 2   | 27  |
| M22x1.5     | 6090010023  | 10 | 27 | 25 | 1,5 | 27  |
| M22x1.5     | 6090010024  | 12 | 25 | 25 | 1,5 | 27  |
| M22x1.5     | 6090010026  | 15 | 27 | 25 | 1,5 | 27  |
| M38x1.5     | 6090010030  | 12 | 30 | 25 | 2   | 46  |

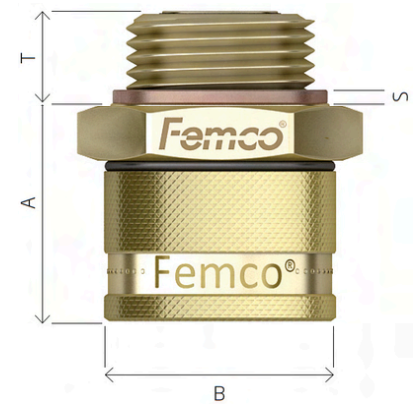

### NPT sizes

| Thread size | Item number | T  | A  | B  | S   | Hex |
|-------------|-------------|----|----|----|-----|-----|
| 3/8-18 NPT  | 6060010107  | 10 | 27 | 25 | n/a | 22  |
| 1/4-18 NPT  | 6060010106  | 9  | 27 | 25 | n/a | 22  |
| 1/2-14 NPT  | 6060010108  | 10 | 27 | 25 | n/a | 27  |
| 1/2-14 NPT  | 6060010109  | 12 | 25 | 25 | n/a | 27  |

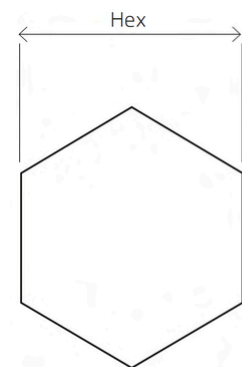

### UNF sizes

| Thread size | Item number | T  | A  | B  | S | Hex |
|-------------|-------------|----|----|----|---|-----|
| 1/2-20 UNF  | 6080010085  | 12 | 25 | 25 | 2 | 22  |
| 1/2-20 UNF  | 6080010087  | 10 | 27 | 25 | 2 | 22  |
| 5/8-18 UNF  | 6080010090  | 9  | 27 | 25 | 2 | 22  |
| 3/4-16 UNF  | 6080010092  | 10 | 27 | 25 | 2 | 27  |
| 3/4-16 UNF  | 6080010093  | 15 | 27 | 25 | 2 | 27  |
| 7/8-14 UNF  | 6080010094  | 10 | 27 | 25 | 2 | 27  |
| 7/8-18 UNF  | 6080010096  | 10 | 27 | 25 | 2 | 27  |
| 7/8-20 UNF  | 6080010097  | 10 | 27 | 25 | 2 | 27  |

*The plugs come standard without a magnet. If you would like a magnet on your plug(s), please request this.  
The dust caps come standard without chain. If you want a chain on your plug(s), please request this.*



# Femco Standard Plug SB (Small Bore)

## Product Specifications



### BSP sizes

| Thread size | Item number | T  | A  | B  | S | Hex |
|-------------|-------------|----|----|----|---|-----|
| 1/4-19 BSP  | 6070010102  | 9  | 27 | 25 | 2 | 22  |
| 3/8-19 BSP  | 6070010103  | 9  | 28 | 25 | 2 | 22  |
| 3/8-19 BSP  | 6070010131  | 10 | 27 | 25 | 2 | 22  |
| 1/2-14 BSP  | 6070010100  | 10 | 27 | 25 | 2 | 27  |
| 3/4-14 BSP  | 6070010134  | 10 | 27 | 25 | 2 | 32  |

### Special sizes

| Thread size   | Item number | Plug   |
|---|-------------|--|
| Special Fit - POM Plug for Scania 13L composite oil pan | 6040010101  |  |

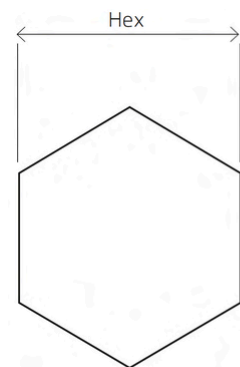
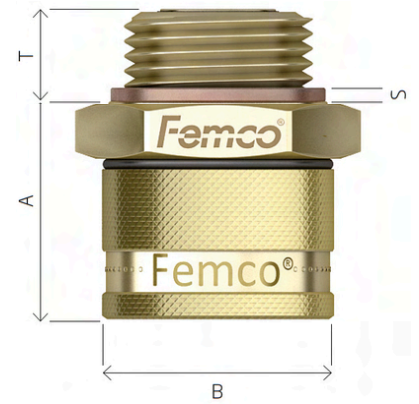

# Femco Standard Accessories

## Product Specifications

All standard **SB** accessories fit all standard **SB** plugs

All Standard **LB** accessories fit all standard **LB** plugs

### Straight Standard Drainer SB/LB

| Description                      | LB/SB     | Thread Size | A  | B  | C  | D  | Item Number |
|----------------------------------|-----------|-------------|----|----|----|----|-------------|
| Straight Drainer                 | <b>SB</b> | M22x1.5     | 25 | 17 | 22 | 15 | 650117      |
| Straight Drainer with hose 25cm  |           |             |    |    |    |    | 650100      |
| Straight Drainer with hose 130cm |           |             |    |    |    |    | 650101      |
| Straight Drainer                 | <b>LB</b> | M26x1.5     | 30 | 20 | 28 | 19 | 650118      |
| Straight Drainer with hose 25cm  |           |             |    |    |    |    | 650103      |
| Straight Drainer with hose 130cm |           |             |    |    |    |    | 650104      |

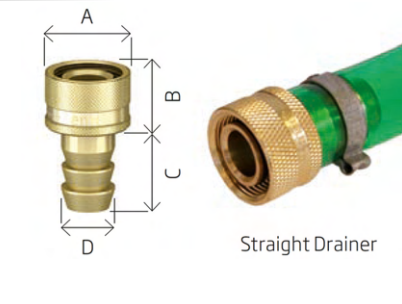

### Angled Standard Drainer 45° SB/LB

| Description                        | LB/SB     | Thread Size | A  | B  | C  | Item Number |
|------------------------------------|-----------|-------------|----|----|----|-------------|
| Angled drainer 45°                 | <b>SB</b> | M22x1.5     | 25 | 17 | 37 | 650127      |
| Angled drainer 45° with hose 25cm  |           |             |    |    |    | 650114      |
| Angled drainer 45° with hose 40cm  |           |             |    |    |    | 650115      |
| Angled drainer 45°                 | <b>LB</b> | M26x1.5     | 30 | 65 | 19 | 650123      |
| Angled drainer 45° with hose 25cm  |           |             |    |    |    | 650121      |
| Angled drainer 45° with hose 130cm |           |             |    |    |    | 650122      |

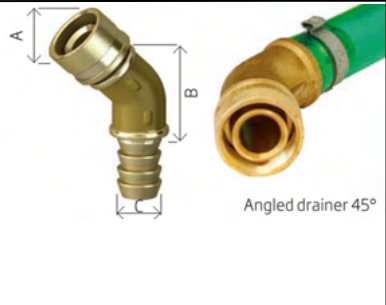

### Angled Standard Drainer 90° SB/LB

| Description                        | LB/SB     | Thread Size | A  | B  | C  | D  | E  | Item Number |
|------------------------------------|-----------|-------------|----|----|----|----|----|-------------|
| Angled drainer 90°                 | <b>SB</b> | M22x1.5     | 25 | 17 | 37 | 34 | 15 | 650119      |
| Angled drainer 90° with hose 25cm  |           |             |    |    |    |    |    | 650106      |
| Angled drainer 90° with hose 130cm |           |             |    |    |    |    |    | 650107      |
| Angled drainer 90°                 | <b>LB</b> | M26x1.5     | 30 | 20 | 40 | 37 | 19 | 650120      |
| Angled drainer 90° with hose 25cm  |           |             |    |    |    |    |    | 650108      |
| Angled drainer 90° with hose 130cm |           |             |    |    |    |    |    | 650109      |

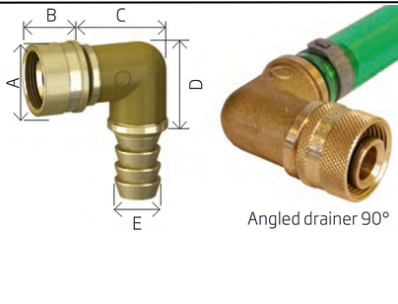

# Femco Standard Accessories

## Product Specifications

All standard **SB** accessories fit all standard **SB** plugs

All Standard **LB** accessories fit all standard **LB** plugs

### Other Accessories

| Description                      | LB/SB     | Item Number |  |
|----------------------------------|-----------|-------------|---|
| Straight drainer to 3/4 NPT-male | <b>SB</b> | 650128      |   |
|                                  | <b>LB</b> | 650134      |   |

| Description                      | LB/SB     | Item Number |  |
|----------------------------------|-----------|-------------|--|
| Straight drainer to 1/2 BSP-male | <b>SB</b> | 650129      |  |
|                                  | <b>LB</b> | 650136      |  |

| Description | LB/SB     | Item Number |  |
|-------------|-----------|-------------|---|
| Dustcap     | <b>SB</b> | 650112      |   |
|             | <b>LB</b> | 650113      |   |

| Description     | LB/SB     | Item Number |  |
|-----------------|-----------|-------------|---|
| Sampling nipple | <b>SB</b> | 951006      |   |
|                 | <b>LB</b> | 951007      |   |

# Femco Compact Plug

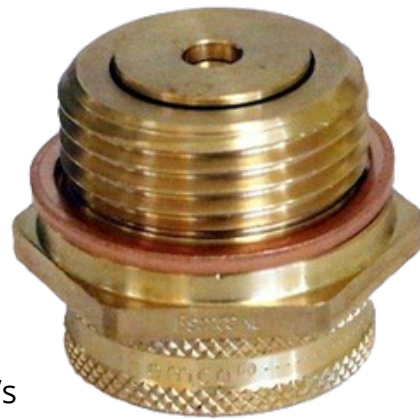

The Compact drain plug has the lowest profile in Femco's product lineup. It's an excellent choice when clearance is a concern. The Compact plug only extends 12 millimetres from the oil pan and can be paired with our low profile Compact 90° degree drainer for extra tight places. Like our other products, the Compact plug is machined from solid brass, a durable, corrosion resistant metal, not prone to conducting heat. The oil drain plug features a dust cover and a two O-ring's, protecting the valve assembly and ensuring reliable performance in the most demanding conditions. There is no need to use heavy wrenches or keys with our plugs.

## How it works:

Install the Femco Compact plug in your engines oil pan. When it's time for an oil change, simply unscrew the dust cap and screw on the Femco drain hose. The action of screwing the hose on opens the internal valve, allowing the waste oil to drain. The drain hose allows for the waste oil to be drained directly into a container for disposal. This can also be paired with a Compact to Click adaptor, for use with waste oil pumps and evacuation units.

## When should you choose the Compact plug?

- Vehicles with low ground clearance (such as a buses, off-road vehicles, and agricultural equipment).
- Small applications such as gearboxes, coolant, transmissions, hydraulics, and HVAC.
- When the drain port is in a tight space or hard-to-reach area.

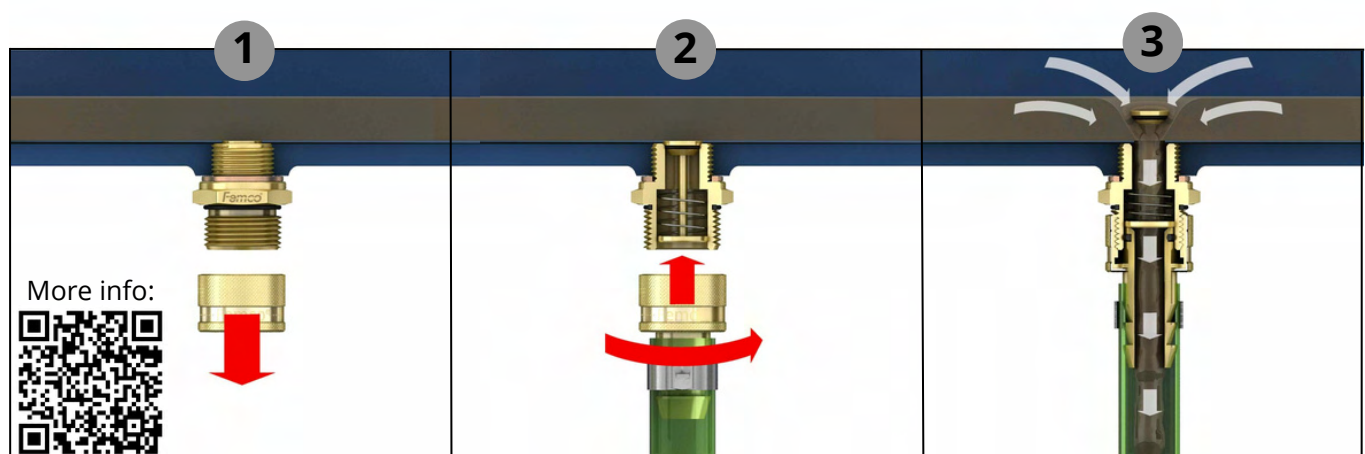

# Femco Compact Plug LB (Large Bore)

## Product Specifications



### Metric sizes

| Thread size | Item number | T  | A  | B  | S | Hex |
|-------------|-------------|----|----|----|---|-----|
| M12x1.25    | 7090020177  | 10 | 12 | 28 | 2 | 30  |
| M12x1.5     | 7090020178  | 10 | 12 | 28 | 2 | 30  |
| M12x1.75    | 7090020170  | 10 | 12 | 28 | 2 | 30  |
| M14x1.25    | 7090020180  | 10 | 12 | 28 | 2 | 30  |
| M14x1.5     | 7090020181  | 10 | 12 | 28 | 2 | 30  |
| M16x1.5     | 7090020184  | 10 | 12 | 28 | 2 | 30  |
| M18x1.5     | 7090020186  | 10 | 12 | 28 | 2 | 30  |
| M18x1.5     | 7090020183  | 14 | 14 | 28 | 2 | 30  |
| M20x1.5     | 7090020189  | 10 | 13 | 28 | 2 | 30  |
| M22x1.5     | 7090020195  | 10 | 12 | 28 | 2 | 30  |
| M22x1.5     | 7090020198  | 15 | 12 | 28 | 2 | 30  |
| M24x1,5     | 7090020203  | 12 | 15 | 28 | 2 | 30  |
| M24x1.5     | 7090020204  | 15 | 12 | 28 | 2 | 30  |
| M24x2.0     | 7090020206  | 12 | 15 | 28 | 2 | 30  |
| M25x1.5     | 7090020210  | 15 | 12 | 28 | 2 | 32  |
| M26x1.5     | 7090020212  | 10 | 12 | 28 | 2 | 32  |
| M27x2.0     | 7090020216  | 12 | 15 | 28 | 2 | 32  |
| M28x1.5     | 7090020339  | 12 | 12 | 28 | 2 | 36  |
| M30x1.5     | 7090020220  | 10 | 12 | 28 | 2 | 36  |
| M32x1.5     | 7090020222  | 12 | 12 | 28 | 2 | 36  |
| M36x1.5     | 7090020337  | 12 | 15 | 28 | 2 | 42  |
| M36x2.0     | 7090020336  | 12 | 15 | 28 | 2 | 42  |

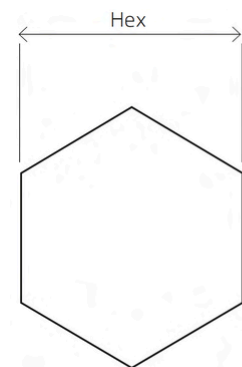
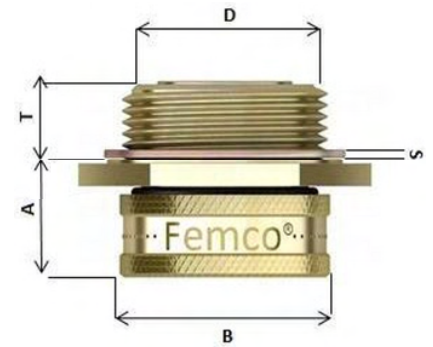

### NPT sizes

| Thread size | Item number | T  | A  | B  | S   | Hex |
|-------------|-------------|----|----|----|-----|-----|
| 3/8-18 NPT  | 7060020407  | 10 | 12 | 28 | n/a | 30  |
| 1/4-18 NPT  | 7060020406  | 10 | 12 | 28 | n/a | 30  |
| 1/2-12 NPT  | 7060020408  | 12 | 12 | 28 | n/a | 30  |
| 3/4-14 NPT  | 7060020412  | 15 | 12 | 28 | n/a | 32  |
| 3/4-14 NPT  | 7060020409  | 12 | 15 | 28 | n/a | 32  |
| 1-11.5      | 7060020413  | 12 | 15 | 28 | n/a | 36  |

*The plugs come standard without a magnet. If you would like a magnet on your plug(s), please request this.  
The dust caps come standard without chain. If you want a chain on your plug(s), please request this.*

# Femco Compact Plug LB (Large Bore)

## Product Specifications



### UNF sizes

| Thread size   | Item number | T  | A                                     | B  | S | Hex |
|---------------|-------------|----|---------------------------------------|----|---|-----|
| 1/2-20 UNF    | 7080020354  | 10 | 12                                    | 28 | 2 | 30  |
| 1/2-20 UNF    | 7080020392  | 12 | 12                                    | 28 | 2 | 30  |
| 3/4-16 UNF    | 7080020358  | 10 | 12                                    | 28 | 2 | 30  |
| 3/4-16 UNF    | 7080020359  | 15 | 12                                    | 28 | 2 | 30  |
| 7/8-14 UNF    | 7080020360  | 10 | 12                                    | 28 | 2 | 30  |
| 7/8-18 UNF    | 7080020363  | 10 | 12                                    | 28 | 2 | 30  |
| 7/8-20 UNF    | 7080020364  | 10 | 12 <td>28</td> <td>2</td> <td>30</td> | 28 | 2 | 30  |
| 1-14 UNF      | 7080020367  | 12 | 15                                    | 28 | 2 | 32  |
| 1 1/8-12 UNF  | 7080020387  | 12 | 15                                    | 28 | 2 | 32  |
| 1 1/16-12 UNF | 7080020377  | 12 | 15                                    | 28 | 2 | 32  |
| 1 5/16-12 UNF | 7080020372  | 12 | 15                                    | 28 | 2 | 32  |
| 1 1/2-12 UNF  | 7080020355  | 12 | 15                                    | 28 | 2 | 46  |

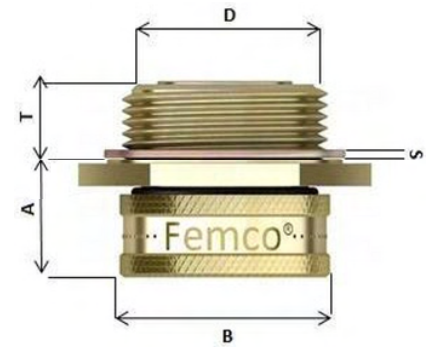

### BSP sizes

| Thread size | Item number | T  | A  | B  | S | Hex |
|-------------|-------------|----|----|----|---|-----|
| 1/2-14 BSP  | 7070020397  | 10 | 12 | 28 | 2 | 30  |
| 3/8-19 BSP  | 7070020396  | 10 | 12 | 28 | 2 | 30  |
| 3/4-14 BSP  | 7070020399  | 12 | 15 | 28 | 2 | 32  |
| 1-11 BSP    | 7070020401  | 12 | 15 | 28 | 2 | 36  |

### UNS sizes

| Thread size | Item number | T  | A  | B  | S | Hex |
|-------------|-------------|----|----|----|---|-----|
| 1-18 UNS    | 7050020417  | 12 | 15 | 28 | 2 | 32  |

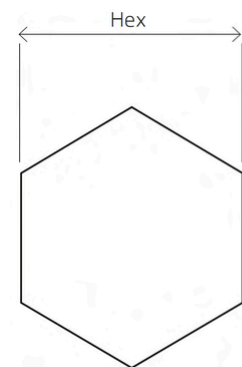

# Femco Compact Plug SB (Small Bore)

## Product Specifications



### Metric sizes

| Thread size | Item number | T  | A  | B  | S | Hex |
|-------------|-------------|----|----|----|---|-----|
| M12x1.25    | 7090010151  | 9  | 12 | 24 | 2 | 22  |
| M12x1.5     | 7090010152  | 9  | 12 | 24 | 2 | 22  |
| M12x1.75    | 7090010153  | 9  | 12 | 24 | 2 | 22  |
| M14x1.25    | 7090010154  | 9  | 12 | 24 | 2 | 22  |
| M14x1.25    | 7090010157  | 12 | 12 | 24 | 2 | 22  |
| M14x1.5     | 7090010156  | 9  | 12 | 24 | 2 | 22  |
| M16x1.5     | 7090010161  | 9  | 12 | 24 | 2 | 22  |
| M18x1.5     | 7090010163  | 10 | 12 | 24 | 2 | 24  |
| M18x1.5     | 7090010166  | 14 | 23 | 24 | 2 | 24  |
| M20x1.5     | 7090010167  | 10 | 12 | 24 | 2 | 27  |
| M22x1.5     | 7090010172  | 10 | 12 | 24 | 2 | 27  |
| M22x1.5     | 7090010174  | 15 | 12 | 24 | 2 | 27  |

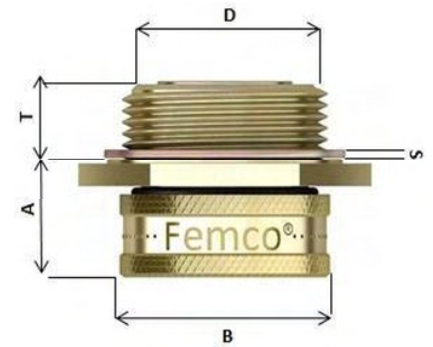

### NPT sizes

| Thread size | Item number | T  | A  | B  | S   | Hex |
|-------------|-------------|----|----|----|-----|-----|
| 1/4-18 NPT  | 7060010350  | 9  | 12 | 24 | n/a | 22  |
| 3/8-18 NPT  | 7060010352  | 9  | 12 | 24 | n/a | 24  |
| 1/2-14 NPT  | 7060010353  | 9  | 12 | 24 | n/a | 27  |
| 1/2-14 NPT  | 7060010354  | 12 | 12 | 24 | n/a | 27  |

### UNF sizes

| Thread size | Item number | T  | A  | B  | S | Hex |
|-------------|-------------|----|----|----|---|-----|
| 1/2-20 UNF  | 7080010334  | 9  | 12 | 24 | 2 | 22  |
| 1/2-20 UNF  | 7080010332  | 12 | 12 | 24 | 2 | 22  |
| 3/4-16 UNF  | 7080010339  | 10 | 12 | 24 | 2 | 24  |
| 3/4-16 UNF  | 7080010340  | 15 | 12 | 24 | 2 | 24  |

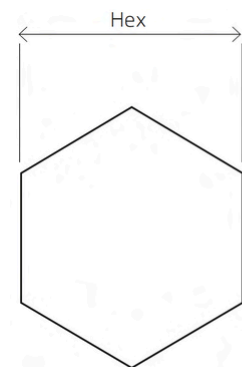

### BSP sizes

| Thread size | Item number | T  | A  | B  | S | Hex |
|-------------|-------------|----|----|----|---|-----|
| 1/4-19 BSP  | 7070010346  | 9  | 12 | 24 | 2 | 22  |
| 3/8-19 BSP  | 7070010347  | 9  | 12 | 24 | 2 | 22  |
| 1/2-14 BSP  | 7070010348  | 10 | 12 | 24 | 2 | 27  |

# Femco Compact Accessories

## Product Specifications

All Compact **SB** accessories fit all Compact **SB** plugs

All Compact **LB** accessories fit all Compact **LB** plugs

### Straight Compact Drainer SB/LB

| Description                      | LB/SB     | Thread Size | A  | B  | C  | D  | Item Number |
|----------------------------------|-----------|-------------|----|----|----|----|-------------|
| Straight Drainer                 | <b>SB</b> | M20x1.25    | 25 | 19 | 24 | 15 | 750003      |
| Straight Drainer with hose 25cm  |           |             |    |    |    |    | 750001      |
| Straight Drainer with hose 130cm |           |             |    |    |    |    | 750002      |
| Straight Drainer                 | <b>LB</b> | M24x1.25    | 30 | 20 | 28 | 19 | 750007      |
| Straight Drainer with hose 25cm  |           |             |    |    |    |    | 750005      |
| Straight Drainer with hose 130cm |           |             |    |    |    |    | 750006      |

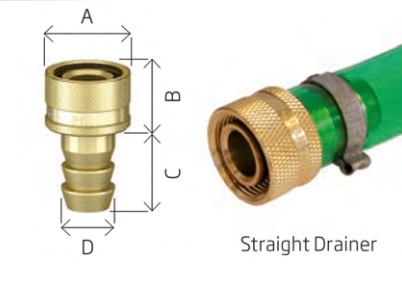

### Angled Compact Drainer 45° SB/LB

| Description                        | LB/SB     | Thread Size | A  | B  | C  | Item Number |
|------------------------------------|-----------|-------------|----|----|----|-------------|
| Angled drainer 45°                 | <b>SB</b> | M20x1.25    | 25 | 65 | 19 | 750040      |
| Angled drainer 45° with hose 25cm  |           |             |    |    |    | 750024      |
| Angled drainer 45° with hose 130cm |           |             |    |    |    | 750041      |
| Angled drainer 45°                 | <b>LB</b> | M24x1.25    | 30 | 65 | 19 | 750026      |
| Angled drainer 45° with hose 25cm  |           |             |    |    |    | 750013      |
| Angled drainer 45° with hose 130cm |           |             |    |    |    | 750014      |



### Angled Compact Drainer 90° SB/LB

| Description                        | LB/SB     | Thread Size | A  | B  | C  | D  | E  | Item Number |
|------------------------------------|-----------|-------------|----|----|----|----|----|-------------|
| Angled drainer 90°                 | <b>SB</b> | M20x1.25    | 25 | 17 | 37 | 34 | 15 | 750009      |
| Angled drainer 90° with hose 25cm  |           |             |    |    |    |    |    | 750004      |
| Angled drainer 90° with hose 130cm |           |             |    |    |    |    |    | 750008      |
| Angled drainer 90°                 | <b>LB</b> | M24x1.25    | 30 | 20 | 40 | 37 | 19 | 750032      |
| Angled drainer 90° with hose 25cm  |           |             |    |    |    |    |    | 750033      |
| Angled drainer 90° with hose 130cm |           |             |    |    |    |    |    | 750034      |

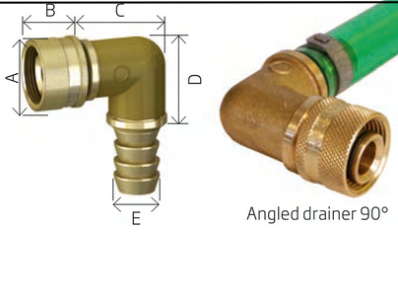



# Femco Compact Accessories

## Product Specifications

All compact **SB** accessories fit all compact **SB** plugs

All compact **LB** accessories fit all compact **LB** plugs

### Compact SB Drainer to Click Drain or Non-Drip

| Description  | LB/SB | Item Number |   |
|--|-------|-------------|---|
| Straight Compact SB to Non-Drip adaptor with 25cm hose | SB    | 750049      |  |
| 90° Compact SB to Non-Drip adaptor with 25cm hose      | SB    | 750051      |   |

### Other Accessories

| Description                              | LB/SB     | Item Number |   |
|--|-----------|-------------|---|
| Straight compact drainer to 3/4 NPT-male | <b>SB</b> | 650128      |  |
|  | <b>LB</b> | 650134      |   |

| Description     | LB/SB     | Item Number |   |
|-----------------|-----------|-------------|---|
| Dustcap compact | <b>SB</b> | 750027      |  |
|                 | <b>LB</b> | 750028      |   |

| Description             | LB/SB     | Item Number |   |
|-------------------------|-----------|-------------|---|
| Compact sampling nipple | <b>SB</b> | 951009      |  |
|                         | <b>LB</b> | 951008      |   |

# Femco Click Drain Plug



The Click Drain is the fastest solution for fluid draining. This system consists of an oil drain plug and a quick connect coupler (Clicker). When it's time for an oil change simply click the Femco Clicker onto the oil drain plug. This opens the internal valve, allowing the oil to flow out. Femco's double clicker comes with a built in non-return valve, making it the ultimate solution for draining fluid with a pump or evacuation unit. With the full set up, most trucks can be fully drained of oil in 10-30 seconds. Our Click drain plug is machined from solid brass, a durable, corrosion resistant metal, not prone to conducting heat. The oil drain plug features a dust cover and a two O-ring's, protecting the valve assembly and ensuring reliable performance in the most demanding conditions. There is no need to use heavy wrenches or keys with our plugs.

## How it works:

Install the Femco Click plug in your engines oil pan. When it's time for an oil change, simply unscrew the dust cap and click on the Femco Clicker to begin draining. This system works great for gravity drain and for use with waste oil pumps and evacuation units.

## When should you choose the Click Drain plug?

- The Click drain is perfect for companies that perform maintenance on a large volume of vehicles or equipment.
- It's easy compatibility with suction units makes it ideal for mobile service.
- The Click drain is not typically used for personal vehicles.

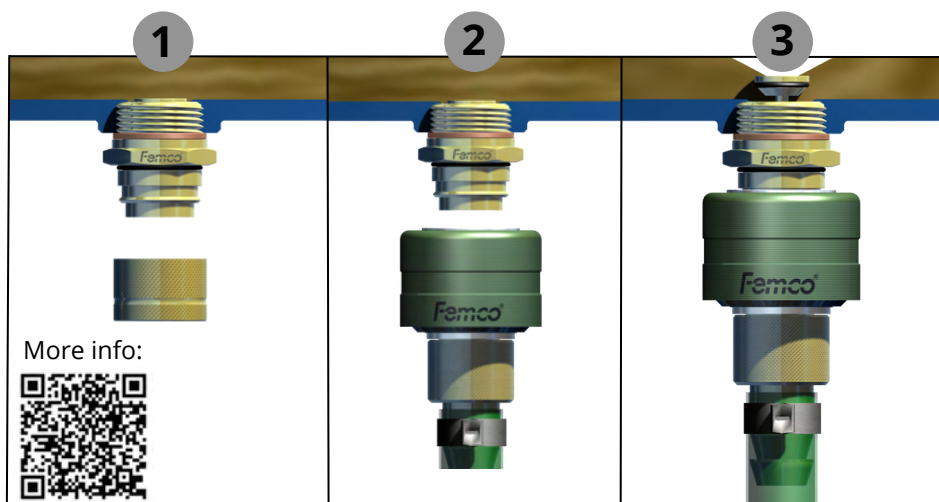

# Femco Click Drain Plug LB (Large Bore)

## Product Specifications



### Metric sizes

| Thread size    | Item number | T  | A  | B  | S      | Hex |
|----------------|-------------|----|----|----|--------|-----|
| M12x1.25       | 8090020419  | 10 | 32 | 30 | 2      | 30  |
| M12x1.5        | 8090020420  | 10 | 32 | 30 | 2      | 30  |
| M12x1.75       | 8090020421  | 10 | 32 | 30 | 2      | 30  |
| M14x1.25       | 8090020422  | 10 | 32 | 30 | 2      | 30  |
| M14x1.5        | 8090020423  | 10 | 32 | 30 | 2      | 30  |
| M16x1.5        | 8090020426  | 10 | 32 | 30 | 2      | 30  |
| M18x1.5        | 8090020428  | 10 | 32 | 30 | 2      | 30  |
| M18x1.5        | 8090020476  | 12 | 30 | 30 | 2      | 30  |
| M18x1.5        | 8090020477  | 14 | 27 | 30 | 2      | 30  |
| M20x1.5        | 8090020432  | 15 | 32 | 30 | 2      | 30  |
| M20x1.5        | 8090020430  | 10 | 32 | 30 | 2      | 30  |
| M22x1.5        | 8090020436  | 10 | 32 | 30 | 2      | 30  |
| M22x1.5        | 8090020437  | 14 | 32 | 30 | 2      | 30  |
| M22x1.5        | 8090020440  | 15 | 32 | 30 | 2      | 30  |
| M24x1.5        | 8090020444  | 12 | 30 | 30 | 2      | 30  |
| M24x1.5        | 8090020445  | 15 | 27 | 30 | 2      | 30  |
| M24x1.5        | 8090020448  | 10 | 42 | 30 | 2      | 30  |
| M24x2.0        | 8090020447  | 12 | 30 | 30 | 2      | 30  |
| M25x1.5        | 8090020451  | 15 | 27 | 30 | 2      | 32  |
| M26x1.5        | 8090020452  | 10 | 30 | 30 | 2      | 32  |
| M26x1.5 50L    | 8090020455  | 10 | 45 | 30 | 2      | 32  |
| M27x2.0        | 8090020458  | 12 | 32 | 30 | 2      | 32  |
| M27x2.0 o-ring | 8090020459  | 12 | 32 | 30 | o-ring | 32  |
| M30x1.5        | 8090020463  | 10 | 32 | 30 | 2      | 36  |
| M32x1.5        | 8090020467  | 12 | 30 | 30 | 2      | 36  |
| M36x2.0        | 8090020471  | 12 | 30 | 30 | 2      | 42  |
| M42x2.0        | 8090020469  | 12 | 30 | 30 | 2      | 50  |

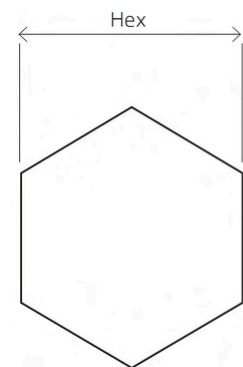
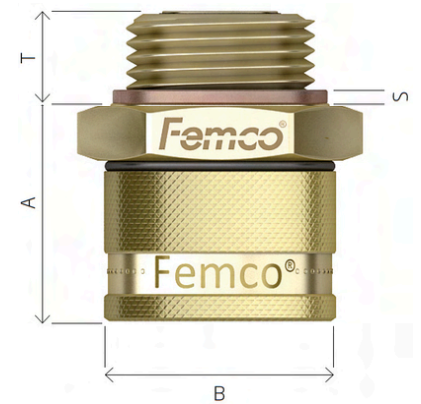

### NPT sizes

| Thread size | Item number | T  | A  | B  | S   | Hex |
|-------------|-------------|----|----|----|-----|-----|
| 3/8-18 NPT  | 8060020512  | 10 | 32 | 30 | n/a | 30  |
| 1/4-18 NPT  | 8060020511  | 10 | 32 | 30 | n/a | 30  |
| 1/2-14 NPT  | 8060020513  | 12 | 32 | 30 | n/a | 30  |
| 3/4-14 NPT  | 8060020514  | 12 | 30 | 30 | n/a | 32  |
| 3/4-14 NPT  | 8060020520  | 15 | 30 | 30 | n/a | 32  |
| 1 11.5-NPT  | 8060020516  | 12 | 27 | 30 | n/a | 36  |

# Femco Click Drain Plug LB (Large Bore)

## Product Specifications



### UNF sizes

| Thread size   | Item number | T  | A  | B  | S | Hex |
|---------------|-------------|----|----|----|---|-----|
| 1/2-20 UNF    | 8080020477  | 10 | 32 | 30 | 2 | 30  |
| 1/2-20 UNF    | 8080020512  | 12 | 32 | 30 | 2 | 30  |
| 3/4-16 UNF    | 8080020481  | 10 | 30 | 30 | 2 | 30  |
| 3/4-16 UNF    | 8080020482  | 15 | 32 | 30 | 2 | 30  |
| 7/8-14 UNF    | 8080020483  | 10 | 32 | 30 | 2 | 30  |
| 7/8-18 UNF    | 8080020486  | 10 | 32 | 30 | 2 | 30  |
| 7/8-20 UNF    | 8080020487  | 10 | 32 | 30 | 2 | 30  |
| 1-14 UNF      | 8080020489  | 12 | 32 | 30 | 2 | 32  |
| 1 1/16-12 UNF | 8080020490  | 15 | 27 | 30 | 2 | 32  |
| 1 1/8-12 UNF  | 8080020498  | 12 | 32 | 30 | 2 | 36  |
| 1 1/8-12 UNF  | 8080020491  | 15 | 27 | 30 | 2 | 36  |
| 1 5/16-12 UNF | 8080020494  | 12 | 30 | 30 | 2 | 36  |
| 1 1/2-12 UNF  | 8080020496  | 12 | 30 | 30 | 2 | 46  |

### BSP sizes

| Thread size | Item number | T  | A  | B  | S | Hex |
|-------------|-------------|----|----|----|---|-----|
| 3/8-19 BSP  | 8080020501  | 10 | 32 | 30 | 2 | 30  |
| 1/2-14 BSP  | 8080020502  | 10 | 32 | 30 | 2 | 30  |
| 3/4-14 BSP  | 8080020505  | 12 | 32 | 30 | 2 | 32  |
| 1-11 BSP    | 8080020506  | 12 | 30 | 30 | 2 | 36  |

### UNS sizes

| Thread size | Item number | T  | A  | B  | S | Hex |
|-------------|-------------|----|----|----|---|-----|
| 1-18 UNS    | 8060020519  | 12 | 30 | 30 | 2 | 32  |

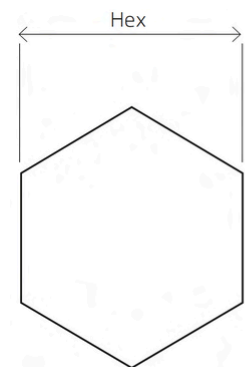
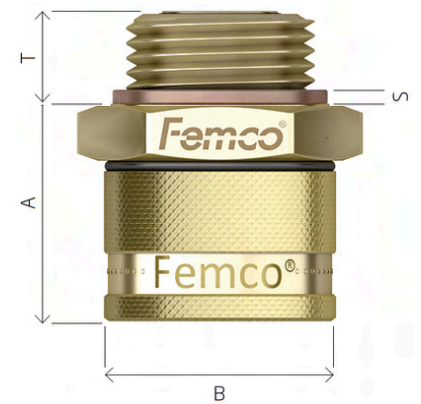

*The plugs come standard without a magnet. If you would like a magnet on your plug(s), please request this.  
The dust caps come standard without chain. If you want a chain on your plug(s), please request this.*

# Femco Click Drain Plug LB (Large Bore)

## Product Specifications



### Special sizes

| Thread size  | Item number  | T  | A  | B  | S | Hex |
|--|--------------|----|----|----|---|-----|
| Special Fit - Hose Connector   | 8090020087   | 15 | 27 | 30 | 0 | 30  |
| M12x1.75 - with extended body  | 8090020130   | 12 | 58 | 30 | 2 | 30  |
| M22x1.5 (8/7L 42)<br>Stainless Steel Pug with extended body<br>Brass valve and dustcap | 8090020439SS | 10 | 37 | 30 | 2 | 32  |
| 1 1/16"-12-UNF<br>Stainless Steel fuel tank plug<br>POM dustcap                        | 8080020490R  | 27 | 27 | 35 | 2 | 32  |
| Special Fit - Aluminum plug for MX13 composite oil pan                                 | 8040020001   |    |    |    |   |     |
| Special Fit - Ford composite oil pan   | 8040020009   |    |    |    |   |     |

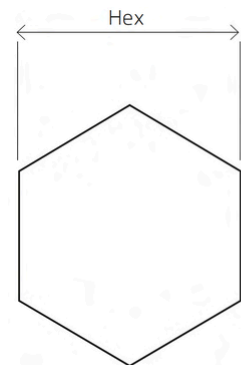
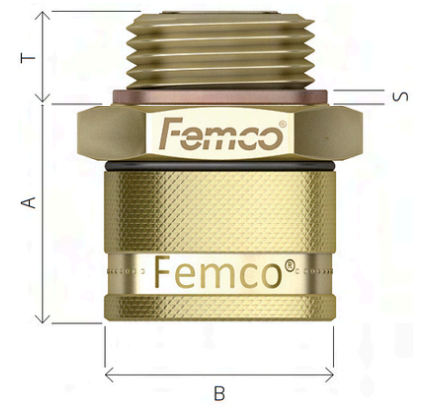

*The plugs come standard without a magnet. If you would like a magnet on your plug(s), please request this.  
The dust caps come standard without chain. If you want a chain on your plug(s), please request this.*



# Femco Click Drain Accessories

## Product Specifications

All Click Drain **LB** accessories fit all Click Drain **LB** plugs

### Solo Clicker

### Double Clicker

| Description             | Item Number |   | Description             | Item Number |
|-------------------------|-------------|---|-------------------------|-------------|
| Straight                | 840001      |  | Straight                | 840010      |
| Straight + 25cm hose    | 840002      |   | Straight + 25cm hose    | 840011      |
| Straight + 130cm hose   | 840003      |   | Straight + 130cm hose   | 840012      |
| Angled 90°              | 840004      |  | Angled 90°              | 840013      |
| Angled 90° + 25cm hose  | 840005      |   | Angled 90° + 25cm hose  | 840014      |
| Angled 90° + 130cm hose | 840006      |   | Angled 90° + 130cm hose | 840015      |
| Angled 45°              | 840007      |  | Angled 45°              | 840016      |
| Angled 45° + 25cm hose  | 840008      |   | Angled 45° + 25cm hose  | 840017      |
| Angled 45° + 130cm hose | 840009      |   | Angled 45° + 130cm hose | 840018      |

### Solo clicker

| Description           | A  | B  | C  | D        | Item Number |
|-----------------------|----|----|----|----------|-------------|
| Solo Clicker 1/2" BSP | 49 | 37 | 12 | 1/2" BSP | 851000      |
| Solo Clicker 1/2" NPT | 49 | 37 | 12 | 1/2" NPT | 851029      |

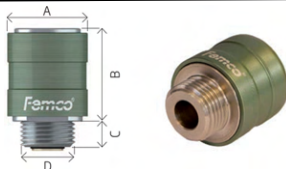

### Double clicker

| Description             | A  | B  | C  | D        | Item Number |
|-------------------------|----|----|----|----------|-------------|
| Double Clicker 3/4" BSP | 49 | 37 | 12 | 3/4" BSP | 851013      |
| Double Clicker 1/2" BSP |    |    |    | 1/2" BSP | 851017      |
| Double Clicker 1" BSP   |    |    |    | 1" BSP   | 851019      |
| Double Clicker 3/4" NPT |    |    |    | 3/4" NPT | 851018      |
| Double Clicker 1/2" NPT |    |    |    | 1/2" NPT | 851028      |

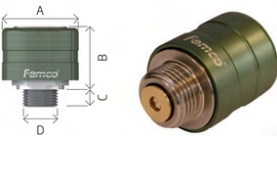

### Double clicker

| Description                                       | Item Number |
|---|-------------|
| Angled drainer 90° to 3/4" NPT-female, with valve | 840037      |
| Straight clicker to 3/4" female, with valve       | 840038      |
| Angled clicker 45° to 3/4" NPT-female             | 840039      |



### Sealing cap

| Description             | Item Number |
|-------------------------|-------------|
| Sealing cap For Clicker | 851000      |



# Femco Non-Drip Plug



Femco's Non-Drip series of fittings and couplers are the cleanest solution for heavy duty truck and equipment maintenance. The Non-Drip utilizes a dry break connection between the drain plug and the coupler (Clicker) to ensure that not a single drop of fluid is exposed or spilled during the draining or filling process. To accelerate the draining or filling process further, the Non-Drip can be used in combination with a EVAC unit or oil pump.

Non-drip plugs are the perfect solution to prevent spills during maintenance. The fully sealed system, with valves in both the plug and coupler, achieves the most efficient, safe, and clean oil changes. With the ability to change fluids without any leftover residue, maintenance teams can safely service their vehicles and equipment in the field.

## How it works:

Install the Femco Non-Drip plug in your engines oil pan. When it's time for an oil change, simply unscrew the dust cap and click on the Non-Drip Clicker to begin draining. This system is best when paired with an oil evacuation unit or pump.

## When should you choose the Non-Drip plug?

- Excellent for field service, or service of particularly dangerous or dirty fluids.
- Perfect for both draining and filling fluid.
- No drips, spills, or residual fluid on either end of the connection.
- Due to the design, the Non-Drip is only available for applications with drain ports of 18mm or larger.

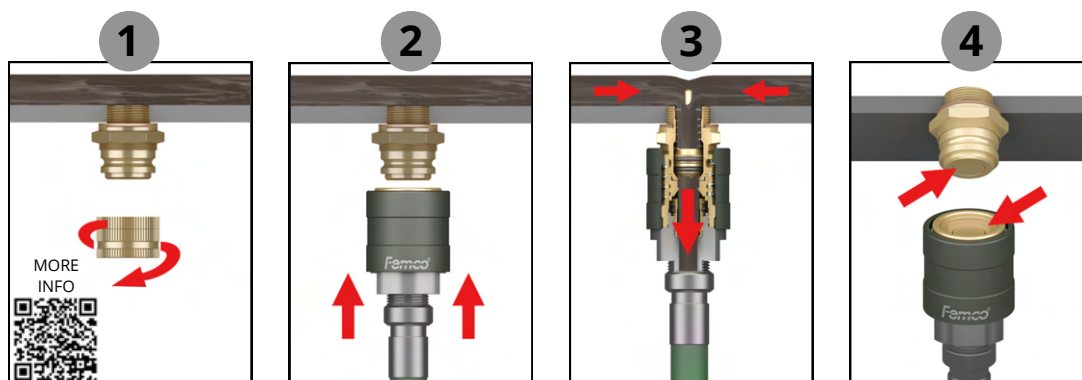

While connecting or disconnecting the drainer, there is **not a drop of oil spilled.**

# Femco Non-Drip Plug LB (Large Bore)

## Product Specifications



### Metric sizes

| Thread size      | Item number | T  | A  | B  | S      | Hex |
|------------------|-------------|----|----|----|--------|-----|
| M12x1.25         | 9090020029  | 10 | 27 | 30 | 2      | 30  |
| M12x1.5          | 9090020030  | 10 | 27 | 30 | 2      | 30  |
| M12x1.75         | 9090020031  | 10 | 27 | 30 | 2      | 30  |
| M14x1.5          | 9090020033  | 10 | 27 | 30 | 2      | 30  |
| M16x1.5          | 9090020036  | 10 | 27 | 30 | 2      | 30  |
| M18x1.5          | 9090020038  | 10 | 27 | 30 | 2      | 30  |
| M20x1.5          | 9090020040  | 10 | 27 | 30 | 2      | 30  |
| M22x1.5          | 9090020046  | 10 | 27 | 30 | 2      | 30  |
| M24x1.5          | 9090020053  | 10 | 27 | 30 | 2      | 30  |
| M24x2.0          | 9090020057  | 10 | 27 | 30 | 2      | 30  |
| M26x1.5          | 9090020063  | 10 | 27 | 30 | 2      | 30  |
| M27x2.0          | 9090020070  | 10 | 27 | 30 | 2      | 30  |
| M27x2.0 + o-ring | 9090020071  | 10 | 27 | 30 | 0-ring | 30  |

### NPT sizes

| Thread size | Item number | T  | A  | B  | S   | Hex |
|-------------|-------------|----|----|----|-----|-----|
| 1/2-14 NPT  | 9060020142  | 12 | 27 | 30 | n/a | 30  |
| 3/4-14 NPT  | 9060020144  | 15 | 27 | 30 | n/a | 30  |
| 1-11.5 NPT  | 9060020145  | 17 | 27 | 30 | n/a | 36  |

### UNF sizes

| Thread size | Item number | T  | A  | B  | S | Hex |
|-------------|-------------|----|----|----|---|-----|
| 7/8-14 UNF  | 9080020115  | 10 | 27 | 30 | 2 | 36  |

### BSP sizes

| Thread size | Item number | T  | A  | B  | S | Hex |
|-------------|-------------|----|----|----|---|-----|
| 1/2-14 BSP  | 9070020132  | 10 | 27 | 30 | 2 | 30  |
| 3/4-14 BSP  | 9070020134  | 10 | 27 | 30 | 2 | 30  |
| 1-11 BSP    | 9070020141  | 10 | 27 | 30 | 2 | 36  |

### UNS sizes

| Thread size | Item number | T  | A  | B  | S | Hex |
|-------------|-------------|----|----|----|---|-----|
| 1-18 UNS    | 9060020148  | 10 | 27 | 30 | 2 | 32  |

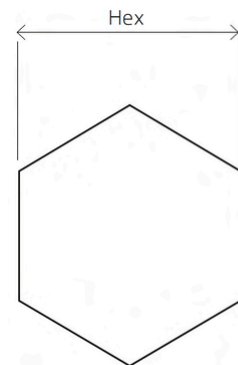
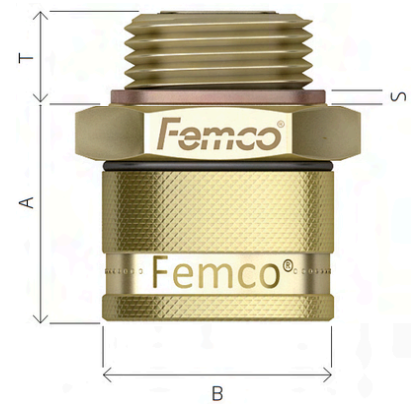

Non-drip drain plugs are not available with a magnet.

The dust caps come standard without chain. If you want a chain on your plug(s), please request this.



# Femco Non-Drip Plug LB (Large Bore)

## Product Specifications



### Non-Drip Plug

| Thread size  | Item number |   |
|--|-------------|---|
| Special Fit - Aluminum plug for Paccar MX11 & MX13 composite oil pan | 9040020001  |  |

### Non-Drip LB Clicker

| Description                        | Item Number |  |
|------------------------------------|-------------|--|
| Non Drip Clicker 1/2" BSP          | 940000      |  |
| Non Drip Clicker 3/4" BSP          | 940001      |  |
| Non Drip Clicker 1" BSP            | 940002      |  |
| Non Drip Clicker 1/2" NPT          | 940003      |  |
| Non Drip Clicker 3/4" NPT          | 940004      |  |
| Non Drip Clicker 1" NPT            | 940005      |  |
| Non Drip Clicker - ESOC Connection | 940007      |  |

# Femco XL Plug



Femco's XL drain plug is the largest option in our lineup. This highly specialized system is designed to maximize flow rate for applications with an exceptionally large volume of fluid. Like our other products, the XL is machined from solid brass, a corrosion resistant material not prone to conducting heat.

Femco XL Drain plugs are not suitable for most vehicles or equipment. **The XL plug is ideal for drain ports 30mm and larger.**

To service fleets of large vehicles and equipment, Femco® has also introduced the XL Click Drain. This quick-coupling system combines the advantages of the XL and the Click Drain plugs. This is ideal for servicing locomotives and mining equipment with an oil evacuation unit or pump.

If you would like more information about the XL plug, please feel free to contact us. Our experienced customer care team is always available to discuss your needs and help determine if the XL plug is a suitable solution.

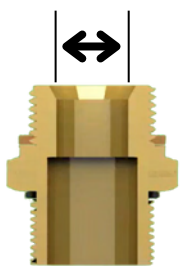

Standard

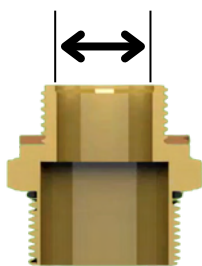

XL



More Info

# Plugs for EV's



## Femco Plugs For EV's

Across heavy equipment, construction, mining, public transit, and trucking, developing practical, easy to service EVs is a priority for many of our OEM clients. As part of an ever evolving industry, Femco is at the forefront of developing new drain solutions to fit these needs. In line with our commitment to global OEMs, Femco has worked to develop several light-weight aluminum alloy drain valves for EV fluid applications. We're aware that weight savings and durability are of utmost importance, and have made sure to deliver a high quality solution. With in-house engineering and production capabilities, we can create specialized drain valves from a wide variety of materials to suit ever evolving industry needs.

Femco's EV valves have proven invaluable for use on EV coolant systems, differential fluid, and many more applications. For custom parts, please feel free to contact us. Together we will design and produce a suitable solution for your needs.

We work with many OEMs in different industries across the world. We adhere to the highest quality standards to ensure we only deliver the finest of finished products. Quality checks are conducted meticulously throughout the entire process, both during and after production.

# Special Parts

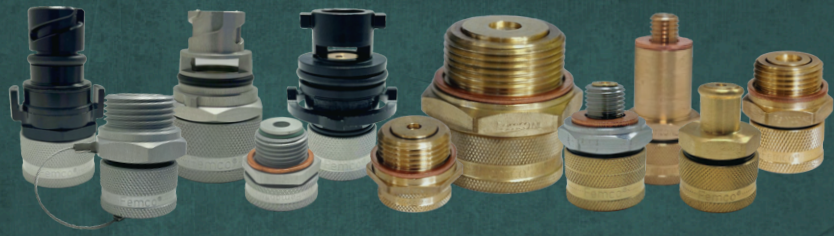

## Femco Special Parts

Femco has an extensive portfolio for the manufacturing of specialized and custom parts. We work with our customers to produce tailor made solutions for unique problems. We're able to achieve this with help of our in-house CNC machine park (specialized CNC machines), professional team of engineers, and 40+ years of industry experience.

We specialize in milling and turning materials such as brass, aluminum, stainless steel and plastics (POM-C) (PVC). We strive to provide the highest quality parts to our customers. We have implemented Statistical Process Control (SPC), Production Part Approval Process (PPAP) and several other quality standards to ensure the quality of our products. This has resulted in ISO 9001 and TUV certification.

With a wide range of OEM customers in different industries, we're well versed in both meeting and exceeding the highest standards. We handle the entire production process from raw material to finished product. By keeping this entire process in-house, we're able to move quickly with the production of samples, prototypes, and free quotations.

Feel free to reach out to us for your special parts requirements. We embrace challenges and in collaboration with you, strive to deliver high-quality solutions. Our team is ready to assist you in the development or design of parts, offering unique insight tailored to your project.

### Why choose Femco?

- In-House engineering and manufacturing.
- Over 40 years of experience.
- Specialist in custom-designed products.
- High standards on quality.



*Welcome to Femco, where precision meets customization, and collaboration results in solutions engineered with utmost proficiency.*



*Empowering Progress, Engineering Excellence -  
Femco Draintechnology  
Where innovation meets efficiency.*

*Your journey to superior drainage solutions begins here.*



**Femco USA Inc.**

22722 29th Dr SE, Suite 100  
Bothell WA 98021  
United States

 +1 425 318 6050

 +1 800 340 2147

 [usa@femco.com](mailto:usa@femco.com)

**Femco Drain Technology B.V.**

Rendementsweg 7  
3641 SK Mijdrecht  
The Netherlands

 +31 (0)297 - 23 02 05

 [info@femco.com](mailto:info@femco.com)