

Oil Drain Valves

THE CLEANEST SOLUTION FOR CHANGING FLUIDS



TABLE OF CONTENTS

<u>About Femco</u>	3
<u>Application List (A-Z)</u>	4
<u>Femco Standard Plug</u>	12
<u>Femco Compact Plug</u>	20
<u>Femco Click Drain Plug</u>	26
<u>Femco Non-Drip Plug</u>	31
<u>Femco XL Plug</u>	33
<u>Plugs for EV's</u>	34
<u>Special Parts</u>	35

United States Office:

Femco USA Inc.
 22722 29th Dr SE, Suite 100
 Bothell WA 98021
 United States
 ☎ +1 425 318 6050
 ☎ +1 800 340 2147
 ✉ usa@femco.com

European Office:

Femco Drain Technology B.V
 Rendementsweg 7
 3641 SK Mijdrecht
 The Netherlands
 ☎ +31 (0)297 – 23 02 05
 ✉ info@femco.com

Femco® Draintechnology

Femco® Draintechnology is home of the original quick connect drain plug. Since 1983, we have designed and manufactured our products in-house at our facility in The Netherlands. Our commitment to clients has enabled us to deliver exceptional products, with the innovation and development that has been key to making Femco an industry standard.

Femco's systems bring enhanced efficiency, safety, and cleanliness to equipment maintenance. With over 600 unique sizes, we always have a suitable solution. Femco drain plugs are versatile and can be used for various liquids, including but not limited to engine oil, hydraulic fluid, gearbox oil, and coolant. Femco also offers oil drain valves for fuel tanks.

What are the advantages of the Femco® drainage system?

- Reduced downtime during service.
- The ability to safely drain oil at operating temperature.
- Waste oil is contained from oil pan to container, eliminating risk of spills.
- Eliminates the risk of stripped threads.
- No heavy wrench necessary, all you need is the drain hose.
- Eliminates risk of environmental pollution during field or mobile service.

This catalog includes an application guide for common truck, bus, automotive, industrial, and agricultural engines, along with a lineup of Femco's standard product offerings.

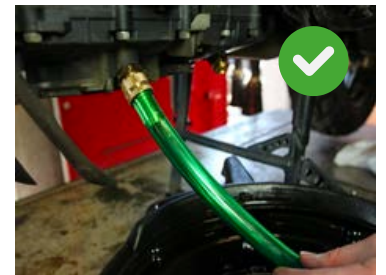

If you want more information please feel free to contact us.



**Faster
 Oil Change**



**Safer
 Oil Change**



**Easy
 To Use**

Application list (A-Z)

Below is an application guide covering common engines, their OEM drain plug thread pitch, and compatible Femco part numbers.

Can't find your size? Our website features a more comprehensive search engine with more engines and equipment. Visit www.femco.com or scan the QR code:



CASE-IH

Application	Thread Size	LB/SB	Standard	Click Drain	Compact
NPT Plugs	1-11.5-NPT-T12	LB	6060020145	8060020516	7060020413
9250-9280, 9350-9390	1-18-UNS-T12	LB	6060020148	8060020519	7050020417
3304 , 3508 , Some 3306	1 1/2-12-UNF-T12	LB	6080020128	8080020496	7080020355
STX Tractors w/Cummins QSX	M27x2.0-T12	LB	6090020070	8090020458	7090020216
Acert C27 (Driver, Rear, pass. Front)	1 5/16-12-UNF-T12	LB	6080020125	8080020494	7080020372
C4.4, 3054, 3056, 3204 Plug on side: C7, C9, 3116, 3126	3/4-16-UNF-T10	LB	6080020113	8080020481	7080020358
305, 359, 504.5, 505CID, MAGNUM SERIES, 5120-9240 w/ Cummins 5.9, 8.3L Plug on bottom: C7, C9, 3116, 3126	M18x1.5-T14	LB	6090020037	8090020477	7090020183
3176 , 3412 , 3406 , 3408 , some 3306 C10, C11, C12, C13, C15, C16, C18 Acert C27 (Pass. Rear, Driver Front)	1 1/8-12-UNF-T15	LB	6080020123	8080020491	7080020387
OEM: 688067C1, 445097, 41300HA, 359875R1, 445096 D282, D312, D360, D407, D414, D436, DT407, DT414, DT429, DT436, DT466, V800 Case-IH Combine: 1440, 1460, 1480 Case-IH Cotton Picker: 1822, 1844 Case-IH Industrial/Construction: 2656, 2706, 2856, 21026, 21256, 21456 Case IH-Tractor: 100, 130, 140, 154, 230, 240, 275, 330, 340, 350, 354, 384, 400, 404, 414, 424, 434, 444, 450, 454, 460, 464, 504, 544, 560, 574, 600, 606, 650, 656, 660, 666, 674, 686, 706, 756, 766, 806, 826, 856, 886, 966, 986, 1066, 1026, 1086, 1206, 1256, 1456, 1466, 1486, 1566, 1586, 2400, 2404, 2424, 2444, 2500, 2606, 3388, 3414, 3444, 3488, 3588, 3688, 3788, 4100, 4156, 4366, 4386, 4568, 4586, 4786, 5088, 5288, 5488, 6388, 6588, 6788, TD5, Early 500	7/8-18-UNF-T10	LB	6080020118	8080020486	7080020363

Application list (A-Z)

CATERPILLAR

Application	Thread Size	LB/SB	Standard	Click Drain	Compact
CT11-15	M27x2.0-T12	LB	6090020070	8090020458	7090020216
CAT745C	1-11-BSP-T12	LB	6070020141	8080020506	7070020401
KT1150, QSKT19, KTTA19	1 1/16-12-UNF-T15	LB	6080020122	8080020490	7080020386
3054, 3056, 3204, 3208, 4.4L	3/4-16-UNF-T10	LB	6080020113	8080020481	7080020358
Fuel Tank: 793F, 777G, 994H	1 1/16"-12-UNF-T27	LB		8080020490R	
All CAT's with tapered pipe plug	1-11.5-NPT-T12	LB	6060020145	8060020516	7060020413
936, 950, 3304, 3508, 3306(some), 3044C	1 1/2-12-UNF-T12	LB	6080020128	8080020496	7080020355
3116, 3126, 3126B, C4, C7, C9 (plug on the bottom)	M18x1.5-T14	LB	6090020037	8090020477	7090020183
299D, 299D XHP, 300.9D, 3011C, 3013C, 3014, 3024, 3024C, 303.5, 303E, 304E2, 305E2, C1.1, C1.5, C1.6, C1.7, C2.2, C22, CH3XL2.22TIC, XQ20	M16x1.5-T10	LB	6090020036	8090020426	7090020184
3176, 3406, 3408, 3412, C10, C11, C12, C13, C14, C15, C16, C18, C27, C30, 3306 (some) OEM #: 9X6451	1 1/8-12-UNF-T15	LB	6080020123	8080020491	7080020387
1100, 1140, 1145, 1150, 1160, 24H, 24M, 308E2, 3100, 3114, 3116, 3126, 3126B (oil drain plug on side), 3126E, 3208, 430F, 446, 446B, 446D, 65C, 65E, 69D, 725, 725C, 730, 730, 730C, 730C, 75C, 75D, 75E, 85C, 85D, 85E, 924K, 930K, 938, 938K, 95E, BH, C-6, C-7, C-9, CX31-C9I, MTC735, R2900, TH31-E61	3/4-16-UNF-T15	LB	6080020114	8080020482	7080020359

CHEVROLET

Application	Thread Size	LB/SB	Standard	Click Drain	Compact
C10, C20, C30, C1500, C2500, C3500, G10, G20, G30, K10, K20, K30, K1500, K2500, K3500, R0, R10, R30, R1500, R2500, R3500 Most older Chevy/GMCars trucks	1/2-20-UNF-T12	SB LB	6080010085 6080020136	8080020512	7080010332 7080020392
Most 1990 and newer Chevy/GM cars & trucks Duramax Diesel (2017+)	M12x1.75-T9	SB	6090010004		7090010153
Duramax Diesel (2001-2016)	M14x1.5-T12	SB	6090010021		7090010155

Application list (A-Z)

CUMMINS

Application	Thread Size	LB/SB	Standard	Click Drain	Compact
X12	M22x1.5-T10 (8/4)	LB	6090020047	8090020436	
QSK 23	M28x1.5-T12	LB	6090020075	8090020464	7090020339
QSK45, QSK60	M42x2.0-T12	LB	6090020090	8090020469	-
A2000, A2300	M14x1.5-T10	LB	6090020033	8090020423	7090020181
QSK, VT504, 555, 378V6	3/4-16-UNF-T10	LB	6080020113	8080020481	7080020358
KT1150, KTTA19, QSKT19	1 1/16-12-UNF-T15	LB	6080020122	8080020490	7080020386
1995-2002 Dodge 5.9L Diesel	M22x1.5-T15	SB LB	6090010026 6090020049	8090010441 8090020440	7090010174 7090020198
ISX, ISZ13, X15 OEM: 4926565, 3680534	M27x2.0-T12 o-ring	LB	6090020071	8090020459	
QSX, QST30, N15, X15, Sig. 600	M27x2.0-T12	LB	6090020070	8090020458	7090020216
B6.7 Other 6.7L Diesel, 3.3L, 4.5, QSB (side port) (Some: ISB, ISC, ISL, QSL, 6B, 6C)	M22x1.5-T10	SB LB	6090010023 6090020046	8090010436 8090020436	7090010172 7090020195
ISM, L10, M11, N14, NH, NT, NTC, QSM, QSK50, 350NT, 444, 855 OEM: 3055069	1-18-UNS-T12	LB	6060020148	8060020519	7050020417
5.9L CPL2071, 8.3L (Most ISB, ISC, ISL, QSL 6B, 6C, ISLG, ISQ, QSC, B&C Series, 4BT3.9, 6BT5.9, 8.3L, 355) Pre 1995 Dodge 5.9L Diesel 2003-2006 Dodge 5.9L Diesel, Dodge 6.7L Diesel, QSB (bottom plug)	M18x1.5-T14	LB	6090020037	8090020477	7090020183

DETROIT DIESEL

Application	Thread Size	LB/SB	Standard	Click Drain	Compact
30 Series	M14x1.25-T10	LB	6090020032	8090020422	-
40 Series	M25x1.5-T15	LB	6090020061	8090020451	7090020210
DD5, DD8	M22x1.5-T10	LB	6090020046	8090020436	7090020195
50 & 60 Series, 352, 353, 453, 652, 853	3/4-14-NPT-T15	LB	6060020144	8060020520	7060020411
DD13, DD15, DD16, V8, V12 2000, 4000 Series	M27x2.0-T12	LB	6090020070	8090020458	7090020216
6V92, 6V71, 8V92, 8V71, 471T 53, 71, 92, Other Small Engines	1/2-14-NPT-T12	SB LB	6060010109 6060020143	8060010514 8060020513	7060010354 7060020408

Application list (A-Z)

DODGE

Application	Thread Size	LB/SB	Standard	Click Drain	Compact
All 3.9L, 5.2L, 5.9L, 8.0L, 8.1L, 8.3L Pre1999 2.7L, 3.2L, 3.3L, 3.5L, 3.8L	1/2-20-UNF-T10	LB	6080020109	8080020477	7080020354
All 1.7L, 1.8L, 2.0L, 2.4L, 2.6L, 3.0L, 3.6L, 3.7L, 5.7L, 6.1L 1999 + 2.7L, 3.2L, 3.3L, 3.5L, 3.8L	M14x1.5-T10	LB	6090020033	8090020423	7090020181
Cummins 5.9L Diesel Pre 1995 Cummins 5.9L Diesel 2003-2006 Cummins 6.7L Diesel	M18x1.5-T14	LB	6090020037	8090020477	7090020183
Cummins 5.9L Diesel 1995-2002	M22X1.5-T15	LB	6090020049	8090020440	7090020198

FORD

Application	Thread Size	LB/SB	Standard	Click Drain	Compact
Replacement standard yellow OEM plug OEM: BC3Z-6730-A / FT4Z-6730-A / KX6Z- 6730-B Certain Ford trucks from 2015-2021 Ford Mustang Ford Edge SUVs	Ford Special	LB	6420001	8040020009	-
Powerstroke 6.0L, 6.4L, 6.7L, 7.3L	M14x1.25-T10	LB	6090020032	8090020422	7090020180
Ford 7.3L (extended collar) Ford 6.8L gas V8 2023+ (extended collar)	M12x1.75-T12	LB	6090020130	8090020412	
1991+ 5.4L, 1993+ 5.8L 1997-2010: 5.0L, 7.5L, V10-6.8L	M14x1.5-T10	LB	6090020033	8090020423	7090020181
Pre 1997 5.0L, Pre1993 5.8L 1987-1994 7.3L Diesel	1/2-20-UNF-T10	LB	6080020109	8080020477	7080020354
Duratec 24 valve 3.0L & 3.5L 1996 + 4.2L, 1996 -2003 2.3L 2.5L SOHC. 1995 + V6-2.5L, 2011 +5.0L	M12x1.75-T9	SB	6090010004		7090010153

Application list (A-Z)

HINO

Application	Thread Size	LB/SB	Standard	Click Drain	Compact
EC100, H06C, H07C, W04C	M22x1.5-T10	LB	6090020046	8090020436	7090020195
DS50, EL100, EM100, EP100, E13C	M30x1.5-T10	LB	6090020074	8090020463	7090020220
F17D, F20C, F21C, J05C, J08C, J08E, K13C, S05D, W04D	M18x1.5-T14	LB	6090020037	8090020477	7090020183

INTERNATIONAL

Application	Thread Size	LB/SB	Standard	Click Drain	Compact
MaxxFace 11, 13, 15	M27x2.0-T12	LB	6090020070	8090020458	7090020216
152, 187, 304, 345, 392, 360	1/2-20-UNF-T10	LB	6080020109	8080020477	7080020354
VT275, VT365, T444E, MaxxFace 5 & 7	M14x1.25-T10	LB	6090020032	8090020422	7090020180
2006-2009 w/Vin < 2 million DT466 & DT570 MaxxFace 10 Bottom plug	M18x1.5-T14	LB	6090020037	8090020477	7090020183
404, 420 (6.9L), 461, 462, 478, 537, 549, 550, 986, 1086, 1486, 1466, D150, D170, D190 Pre 1995: 466, 551, DT366, DT466, 7.3L	7/8-18-UNF-T10	LB	6080020118	8080020486	7080020363
MaxxFace DT, 9, 10 Side plug DT360, DT408, DT530 1995-2003 DT466 & DT570 2004-2006 & 2006 w/Vin > 2 million DT466 & DT570	M25x1.5-T15	LB	6090020061	8090020451	7090020210

ISUZU

Application	Thread Size	LB/SB	Standard	Click Drain	Compact
4BE1, 4BG2, 4JA1, 4JB1, 4ZC1, C223, C200	M14x1.5-T10	LB	6090020033	8090020423	7090020181
3LB1, 3LD1, 4BC1, 4BC2, 4BD1&2, 4HE1, 4JC1, 4JC2, 4JG2, 4HK1, 4LE1, 6BB1, 6BD1T, 6BF1, 6BG1, 6HK1, 6HF1, 6WG1, B Series, BA1, C240, G161, HE1, Tier 2	M20x1.5-T10	LB	6090020040	8090020430	7090020189
4HK1, 4JJ1, 4L2X DH10H, 6BF1, 6QA1&2, 6RA1, 6RB1, 6SA1&2, 6SB1, 8PA1, 8PB1, 8PC1, 10PA1, 10PB2 OPC1, 10PE1, 12PB1, 12PC1, DA220, DA640, E120, Tier3	M24x2.0-T12	LB	6090020057	8090020447	7090020206

Application list (A-Z)

JOHN DEERE (Parts & Engines)

Application	Thread Size	LB/SB	Standard	Click Drain	Compact
Part# T111565	M16x1.5-T10	LB	6090020036	8090020426	7090020184
Part# RE 46685, R27474	M18x1.5-T14	LB	6090020037	8090020477	7090020183
Part # 15H623 100 Series, 20 Engine GU20374	3/8-18-NPT-T10	SB	6060010107		7060010352
Part# R26727 359+, 404, 466, 619, 850, 955CID	1-14-UNF-T12	LB	6080020121	8080020489	7080020367
Part# RE523251, RE46687, R515195, R116102, RE500611, RE507950 5G, 50G, 60G, 75G, 85G 3029 (Oil Pan #1909), 4045 (Oil Pan #1944), 6068 (Oil Pan #1944), 4022, 4990, 5045D, 7130, 7330	M22x1.5-T10	SB LB	6090010023 6090020046	8090010436 8090020436	7090010172 7090020195
With 855 or L10 Cummins	1-18-UNS-T12	LB	6060020148	8060020519	7050020417
4045 (All, except oil pan # 1944), 6068 (All, except oil pan # 1944), 4045T 160, 643L, 834J, 843K, 843L, JD-EX, JD-EX 160	M18x1.5-T10	LB	6090020037	8090020477	7090020183
Part# T20098 AG TRACTORS: 301-401, 820-830, 1020, 1070, 1520-1530, 2020-30, 2150, 2240-50, 2440, 2630-40, 6100, 6200, 6300, 6400, 6500	7/8-20-UNF-T10	LB	6080020119	8080020487	7080020364
Part# R27175, R39741, R84262 496CID, 4050-4055 SERIES AG TRACTORS: 4755-4960, 7200, 7400, 7600, 7700-7710, 7800-7810, 8100-8420, 8430(new), 9100-9520	1 1/16-12-UNF-T15	LB	6080020122	8080020490	7080020386
Part# M1746T 359CID AG TRACTORS: 2010, 2040, 2350-55, 2550- 55, 2750-2955, 3050-3255, 4030	7/8-14-UNF-T10	LB	6080020115	8080020483	7080020360
AG TRACTORS: 3010-3020, 4000-4020, 4230- 4240, 4430-4440, 4620-4630	1-14-UNF-T12	LB	6080020121	8080020489	7080020367
Part # 15H623 100 Series, 20 Engine GU20374 AG TRACTORS: 105, PC9540	3/8-18-NPT-T10	LB	6060020142	8060020512	7060020407
AG TRACTORS: 7.310	M27x2.0-T12	LB	6090020070	8090020458	7090020216

Application list (A-Z)

KOMATSU

Application	Thread Size	LB/SB	Standard	Click Drain	Compact
WA500-3	1-11.5-NPT-T12	LB	6060020145	8060020516	7060020413
With Perkins	3/4-16-UNF-T10	LB	6080020113	8080020481	7080020358
3D72, 3D72-2BA (SN#1001-3000), 3D75, 3D75N, 3D78, 3D78N, 3D80, 3D84, 3D84N, 4D84	M22x1.5-T10	LB	6090020046	8090020436	7090020195
1D75, 1D84, 2D68E, 2D75, 3D62AE, 3D63, 3D66, 3D68E, 3D72N, 3D78-1F, 3D84, 3D84E, 3D84N-2AA, KDP20T, KDP30T, KDP40T, S3D84, S3D84E	M24x1.5-T15	LB	6090020055	8090020445	7090020204

MACK

Application	Thread Size	LB/SB	Standard	Click Drain	Compact
E9	1/2-14-NPT-T12	SB LB	6060010109 6060020143	8060010514 8060020513	7060010354 7060020408
E3, EC3, EC5, E6	7/8-14-UNF-T10	LB	6080020115	8080020483	7080020360
ASET, E7, CHC, 350	M20x1.5-T10	LB	6090020040	8090020430	7090020189
MP7, MP8, MP10, Midliner	M24x1.5-T15	LB	6090020055	8090020445	7090020204
M200, M250, CS200, CS250	M36x2.0-T12	LB	6090020082	8090020471	7090020337

MERCEDES

Application	Thread Size	LB/SB	Standard	Click Drain	Compact
Atego	M24x1.5-T12	LB	6090020054	8090020444	7090020203
Actros	M20x1.5-T15	LB	6090020044	8090020432	-
OM502LA	M20x1.5-T10	LB	6090020040	8090020430	7090020189
Up to 2005 MBE 4000 (S/N<833529)	M26x1.5-T10 (47L)	LB	6090020066	-	-
OM441LA, OM457HLA, OM906HLA, OM457LA Older Trucks & Bus engines	M26x1.5-T10	LB	6090020063	8090020452	7090020212
MBE 4000 (S/N> 833529), MBE 900/906, OM 460, 926	M22x1.5-T10	SB LB	6090010023 6090020046	8090010436 8090020436	7090010172 7090020195
OM612DE27LA, OM611DELA euro2, OM642DE30LA, OM651DE22LA, OM646DE22LA	M14x1.5-T10	LB	6090020033	8090020423	7090020181

Application list (A-Z)

PACCAR

Application	Thread Size	LB/SB	Standard	Click Drain	Compact
MX (2015 and older)	M26x1.5-T10	LB	6090020063	8090020452	7090020212
MX 11, MX 13 (2016+)	COP Special Plug	-	-	8040020001	-
PX6, PX7, PX8, PX9	M18x1.5-T14	LB	6090020037	8090020477	7090020183

VOLVO

Application	Thread Size	LB/SB	Standard	Click Drain	Compact
FH16	M24x2.0-T12	LB	6090020057	8090020447	7090020206
Grader	M32x1.5-T12	LB	6090020078	8090020467	7090020222
TD Models, Penta, F6, F7, F86, N10.12	7/8-14-UNF-T10	LB	6080020115	8080020483	7080020360
D7, D11, D11A, D11C, D12, D13, D13A, D13C, D16, D16C, D16C7, F12, FH12	M24x1.5-T15	LB	6090020055	8090020445	7090020204

Can't find your size? Our website features a search engine with more engines/equipment. Visit www.femco.com or scan the QR code:



Femco Standard Plug



In 1983 Femco® introduced the Standard plug to make routine oil changes a quick, clean, and more environmentally friendly process.

The Standard plug is machined from solid brass, a durable, corrosion resistant metal, not prone to conducting heat.

The oil drain plug features a dust cover and a two O-ring's, protecting the valve assembly and ensuring reliable performance in the most demanding conditions. There is no need to use heavy wrenches or keys with our plugs.

How it works:

Install the Femco standard plug in your engines oil pan. When it's time for an oil change, simply unscrew the dust cap and screw on the Femco drain hose. The action of screwing the hose on opens the internal valve, allowing the waste oil to drain. The drain hose allows for the waste oil to be drained directly into a container for disposal.

When should you choose the Standard plug?

- The Standard plug is perfect for gravity drain applications.
- For larger drain ports (22mm and above), the Standard LB plug is the best fit (such as heavy equipment and trucks)
- For smaller drain ports, the Standard SB plug is the best fit (such as cars and small/medium equipment).

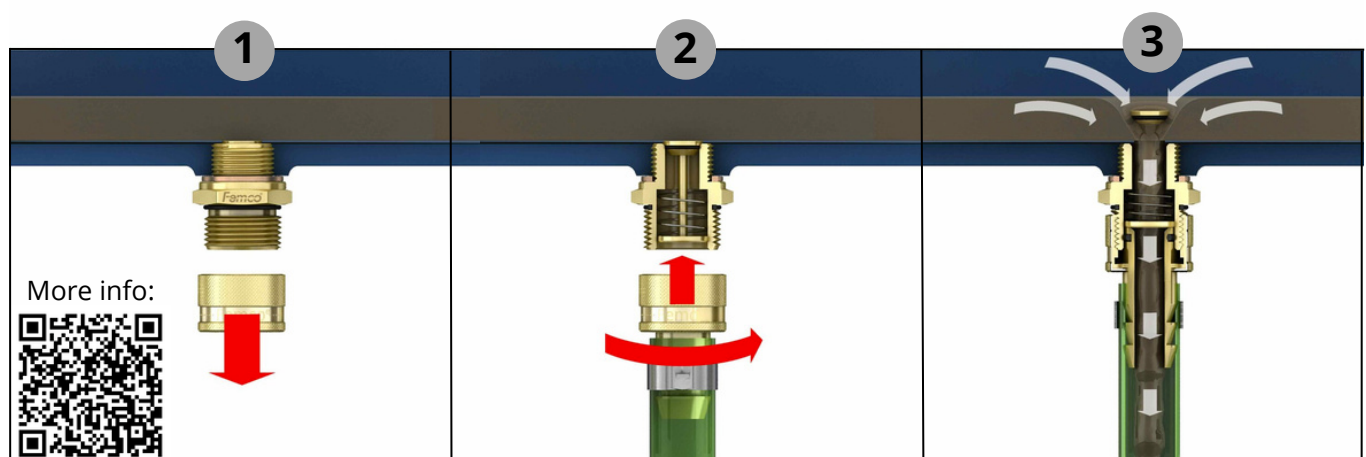

Femco Standard Plug LB (Large Bore)

Product Specifications



Metric sizes

Thread size	Item number	T	A	B	S	Hex
M12x1.25	6090020029	10	32	30	2	30
M12x1.5	6090020030	10	32	30	2	30
M12x1.75	6090020031	10	32	30	2	30
M14x1.25	6090020032	10	32	30	2	30
M14x1.5	6090020033	10	32	30	2	30
M16x1.5	6090020036	10	32	30	2	27
M18x1.5	6090020037	14	28	30	2	30
M18x1.5	6090020038	10	32	30	2	30
M18x1.5	6090020039	15	32	30	2	30
M20x1.5	6090020040	10	32	30	2	30
M20x1.5	6090020044	15	32	30	2	30
M22x1.5	6090020046	10	32	30	2	30
M22x1.5 8/4	6090020047	10	32	30	2	30
M22x1.5	6090020047-01	12	32	30	2	27
M22x1.5	6090020050	17	30	30	2	30
M22x1.5	6090020049	15	32	30	2	30
M24x1.5	6090020053	10	32	30	2	30
M24x1.5	6090020054	12	30	30	2	30
M24x1.5	6090020055	15	28	30	2	30
M24x2.0	6090020057	12	30	30	2	30
M24x2.0	6090020058	21	30	30	2	30
M25x1.5	6090020061	15	27	30	2	32
M26x1.5	6090020063	10	32	30	2	32
M26x1.5	6090020066	10	42	30	2	32
M26x1.5	6090020064	17	25	30	2	32
M26x1.75	6090020067	10	32	30	2	32
M27x2.0	6090020070	12	30	30	2	32
M27x2.0 + o-ring	6090020071	12	30	30	o-ring	32
M28x1.5	6090020076	12	30	30	2	36
M30x1.5	6090020074	10	32	30	2	36
M32x1.5	6090020078	12	30	30	2	36
M36x1.5	6090020081	12	30	30	2	42
M36x2.0	6090020082	12	30	30	2	42
M38x2.0	6090020083	12	32	30	2	46
M42x2.0	6090020090	12	30	30	2	50

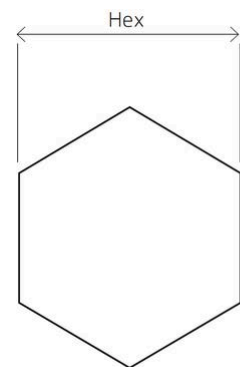
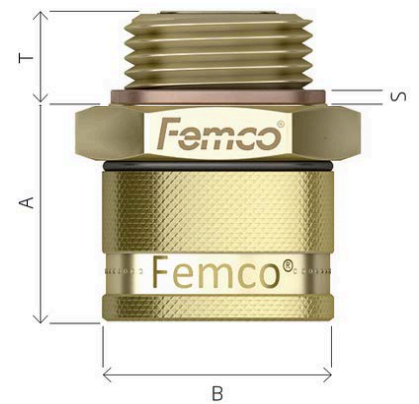

Femco Standard Plug LB (Large Bore)

Product Specifications



NPT sizes

Thread size	Item number	T	A	B	S	Hex
3/8-18 NPT	6060020142	10	32	30	n/a	30
3/4-14 NPT	6060020140	12	30	30	n/a	32
3/4-14 NPT	6060020144	15	27	30	n/a	32
1/2-14 NPT	6060020143	12	30	30	n/a	30
1-11.5 NPT	6060020145	12	30	30	n/a	36

UNF sizes

Thread size	Item number	T	A	B	S	Hex
1/2-20 UNF	6080020109	10	32	30	2	30
1/2-20 UNF	6080020136	12	30	30	2	30
3/4-16 UNF	6080020113	10	32	30	2	30
3/4-16 UNF	6080020114	15	32	30	2	30
7/8-14 UNF	6080020115	10	32	30	2	30
7/8-18 UNF	6080020118	10	32	30	2	30
7/8-20 UNF	6080020119	10	32	30	2	30
1-14 UNF	6080020121	12	30	30	2	32
1 1/16-12 UNF	6080020122	15	27	30	2	32
1 1/16-12 UNF + O-ring	6080020132	15	27	30	2	32
1 1/16-12 UNF	6080020131	25	27	30	2	32
1 1/8-12 UNF	6080020123	15	27	30	2	36
1 1/8-12-UNF	6080020124	12	30	30	2	36
1 5/16-12 UNF	6080020125	12	30	30	2	36
1 5/16-12 UNF	6080020126	15	27	30	2	36
1 1/2-12 UNF	6080020128	12	30	30	2	46

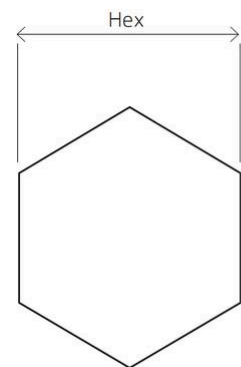
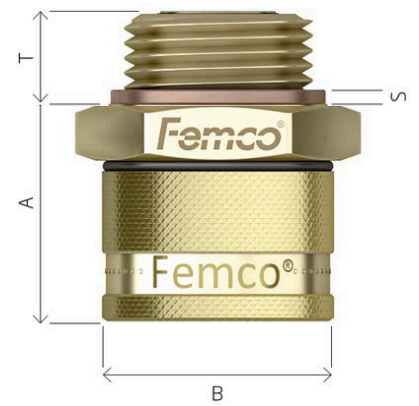



BSP sizes

Thread size	Item number	T	A	B	S	Hex
1/4-19 BSP	6070020130	10	32	30	2	30
3/8-19 BSP	6070020131	10	32	30	2	30
1/2-14 BSP	6070020132	10	32	30	2	30
3/4-14 BSP	6070020134	10	32	30	2	32
1-11 BSP	6070020141	12	30	30	2	36
1 1/2-11 BSP	6070020144	10	30	30	2	55

Femco Standard Plug LB (Large Bore)

Product Specifications

Special sizes

Thread size	Item number	T	A	B	S	Hex
Special Fit - Hose end	6090020087	15	27	30	0	30
						
M12x1.75 - With extended body	6090020130	12	58	30	2	30
						
Special Fit - Ford composite oil pan	6040020001					

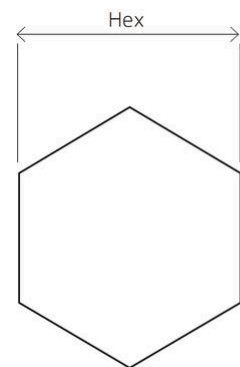
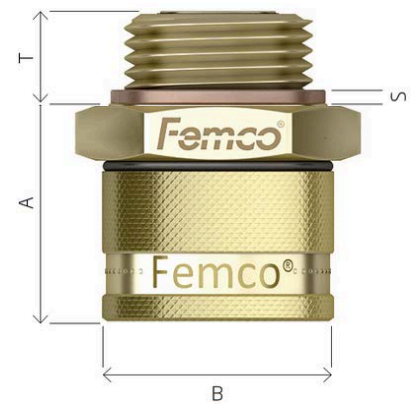

Femco Standard Plug SB (Small Bore)

Product Specifications



Metric sizes

Thread size	Item number	T	A	B	S	Hex
M12x1.25	6090010002	9	27	25	2	22
M12x1.5	6090010003	9	27	25	2	22
M12x1.75	6090010004	9	27	25	2	22
M14x1.25	6090010005	9	27	25	2	22
M14x1.5	6090010007	9	27	25	2	22
M16x1.5	6090010012	9	27	25	2	22
M16x1.5	6090010029	10	32	25	2	22
M16x1.5	6090010013	12	25	25	2	27
M18x1.5	6090010015	12	25	25	2	24
M18x1.5	6090010027	14	27	25	2	24
M20x1.5	6090010018	10	27	25	2	27
M22x1.5	6090010023	10	27	25	1,5	27
M22x1.5	6090010024	12	25	25	1,5	27
M22x1.5	6090010026	15	27	25	1,5	27
M38x1.5	6090010030	12	30	25	2	46

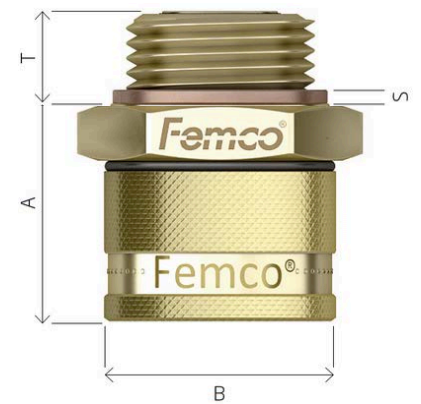

NPT sizes

Thread size	Item number	T	A	B	S	Hex
3/8-18 NPT	6060010107	10	27	25	n/a	22
1/4-18 NPT	6060010106	9	27	25	n/a	22
1/2-14 NPT	6060010108	10	27	25	n/a	27
1/2-14 NPT	6060010109	12	25	25	n/a	27

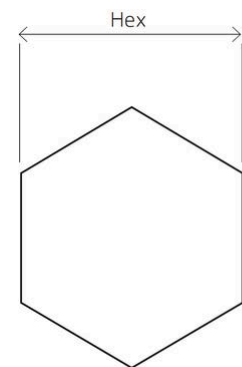

UNF sizes

Thread size	Item number	T	A	B	S	Hex
1/2-20 UNF	6080010085	12	25	25	2	22
1/2-20 UNF	6080010087	10	27	25	2	22
5/8-18 UNF	6080010090	9	27	25	2	22
3/4-16 UNF	6080010092	10	27	25	2	27
3/4-16 UNF	6080010093	15	27	25	2	27
7/8-14 UNF	6080010094	10	27	25	2	27
7/8-18 UNF	6080010096	10	27	25	2	27
7/8-20 UNF	6080010097	10	27	25	2	27

*The plugs come standard without a magnet. If you would like a magnet on your plug(s), please request this.
The dust caps come standard without chain. If you want a chain on your plug(s), please request this.*

Femco Standard Plug SB (Small Bore)

Product Specifications



BSP sizes

Thread size	Item number	T	A	B	S	Hex
1/4-19 BSP	6070010102	9	27	25	2	22
3/8-19 BSP	6070010103	9	28	25	2	22
3/8-19 BSP	6070010131	10	27	25	2	22
1/2-14 BSP	6070010100	10	27	25	2	27
3/4-14 BSP	6070010134	10	27	25	2	32

Special sizes

Thread size	Item number	Plug
Special Fit - POM Plug for Scania 13L composite oil pan	6040010101	

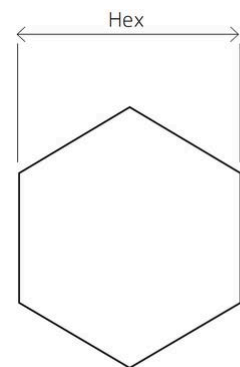
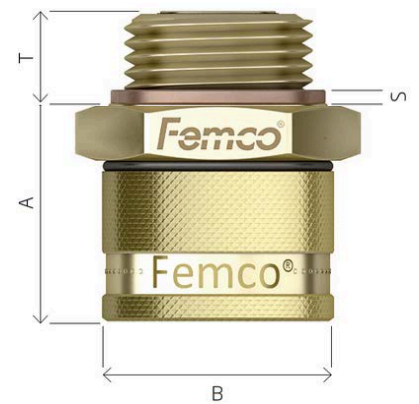

Femco Standard Accessories

Product Specifications

All standard **SB** accessories fit all standard **SB** plugs

All Standard **LB** accessories fit all standard **LB** plugs

Straight Standard Drainer SB/LB

Description	LB/SB	Thread Size	A	B	C	D	Item Number
Straight Drainer	SB	M22x1.5	25	17	22	15	650117
Straight Drainer with hose 25cm							650100
Straight Drainer with hose 130cm							650101
Straight Drainer	LB	M26x1.5	30	20	28	19	650118
Straight Drainer with hose 25cm							650103
Straight Drainer with hose 130cm							650104

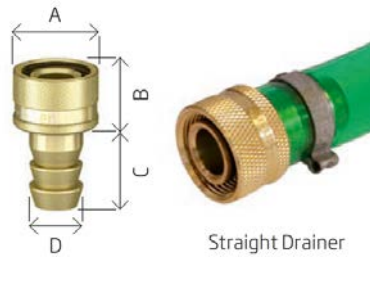

Angled Standard Drainer 45° SB/LB

Description	LB/SB	Thread Size	A	B	C	Item Number
Angled drainer 45°	SB	M22x1.5	25	17	37	650127
Angled drainer 45° with hose 25cm						650114
Angled drainer 45° with hose 40cm						650115
Angled drainer 45°	LB	M26x1.5	30	65	19	650127
Angled drainer 45° with hose 25cm						650114
Angled drainer 45° with hose 130cm						650114

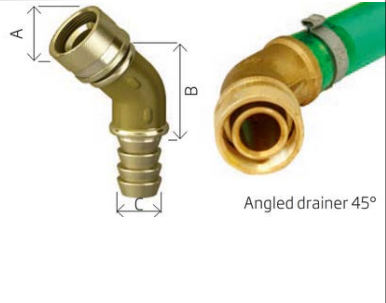

Angled Standard Drainer 90° SB/LB

Description	LB/SB	Thread Size	A	B	C	D	E	Item Number
Angled drainer 90°	SB	M22x1.5	25	17	37	34	15	650119
Angled drainer 90° with hose 25cm								650106
Angled drainer 90° with hose 130cm								650107
Angled drainer 90°	LB	M26x1.5	30	20	40	37	19	650120
Angled drainer 90° with hose 25cm								650108
Angled drainer 90° with hose 130cm								650109

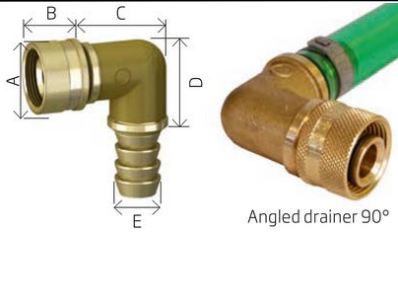

Femco Standard Accessories

Product Specifications

All standard **SB** accessories fit all standard **SB** plugs

All Standard **LB** accessories fit all standard **LB** plugs

Other Accessories

Description	LB/SB	Item Number	
Straight drainer to 3/4 NPT-male	SB	650128	
	LB	650134	

Description	LB/SB	Item Number	
Straight drainer to 1/2 BSP-male	SB	650129	
	LB	650136	

Description	LB/SB	Item Number	
Dustcap	SB	650112	
	LB	650113	

Description	LB/SB	Item Number	
Sampling nipple	SB	951006	
	LB	951007	

Femco Compact Plug

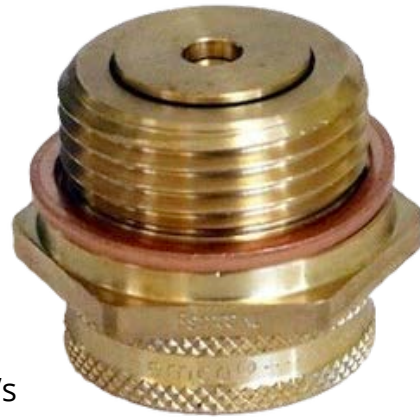

The Compact drain plug has the lowest profile in Femco's product lineup. It's an excellent choice when clearance is a concern. The Compact plug only extends 12 millimetres from the oil pan and can be paired with our low profile Compact 90° degree drainer for extra tight places. Like our other products, the Compact plug is machined from solid brass, a durable, corrosion resistant metal, not prone to conducting heat. The oil drain plug features a dust cover and a two O-ring's, protecting the valve assembly and ensuring reliable performance in the most demanding conditions. There is no need to use heavy wrenches or keys with our plugs.

How it works:

Install the Femco Compact plug in your engines oil pan. When it's time for an oil change, simply unscrew the dust cap and screw on the Femco drain hose. The action of screwing the hose on opens the internal valve, allowing the waste oil to drain. The drain hose allows for the waste oil to be drained directly into a container for disposal. This can also be paired with a Compact to Click adaptor, for use with waste oil pumps and evacuation units.

When should you choose the Compact plug?

- Vehicles with low ground clearance (such as a buses, off-road vehicles, and agricultural equipment).
- Small applications such as gearboxes, coolant, transmissions, hydraulics, and HVAC.
- When the drain port is in a tight space or hard-to-reach area.

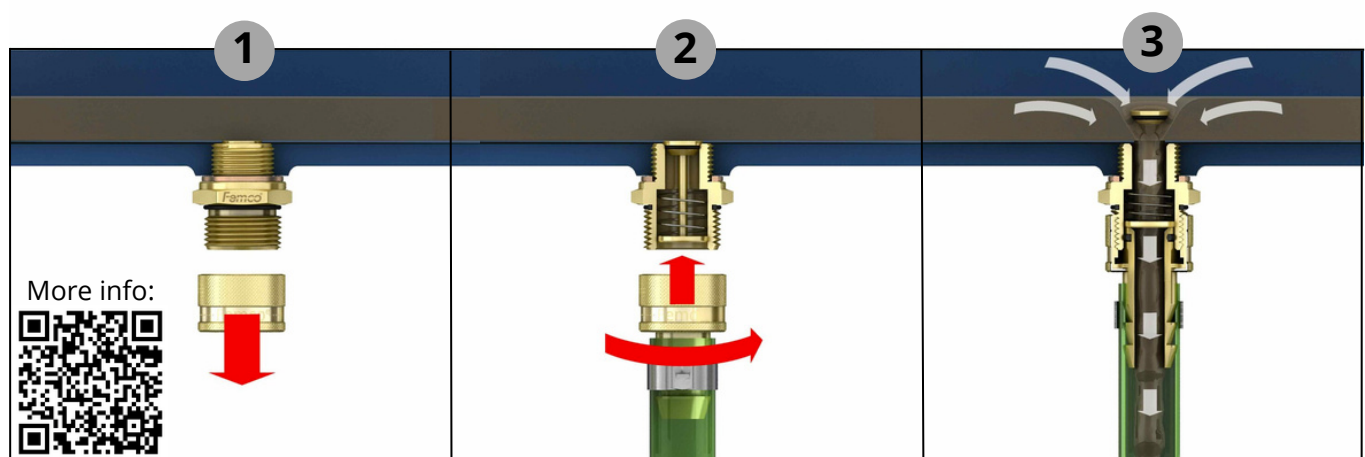

Femco Compact Plug LB (Large Bore)

Product Specifications



Metric sizes

Thread size	Item number	T	A	B	S	Hex
M12x1.25	7090020177	10	12	28	2	30
M12x1.5	7090020178	10	12	28	2	30
M12x1.75	7090020170	10	12	28	2	30
M14x1.25	7090020180	10	12	28	2	30
M14x1.5	7090020181	10	12	28	2	30
M16x1.5	7090020184	10	12	28	2	30
M18x1.5	7090020186	10	12	28	2	30
M18x1.5	7090020183	14	14	28	2	30
M20x1.5	7090020189	10	13	28	2	30
M22x1.5	7090020195	10	12	28	2	30
M22x1.5	7090020198	15	12	28	2	30
M24x1,5	7090020203	12	15	28	2	30
M24x1.5	7090020204	15	12	28	2	30
M24x2.0	7090020206	12	15	28	2	30
M25x1.5	7090020210	15	12	28	2	32
M26x1.5	7090020212	10	12	28	2	32
M27x2.0	7090020216	12	15	28	2	32
M28x1.5	7090020339	12	12	28	2	36
M30x1.5	7090020220	10	12	28	2	36
M32x1.5	7090020222	12	12	28	2	36
M36x1.5	7090020337	12	15	28	2	42
M36x2.0	7090020336	12	15	28	2	42

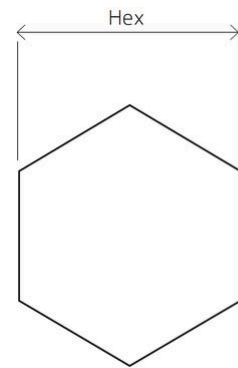
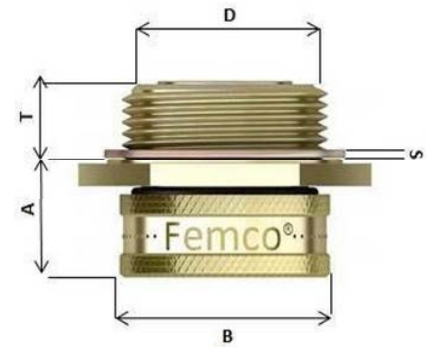

NPT sizes

Thread size	Item number	T	A	B	S	Hex
3/8-18 NPT	7060020407	10	12	28	n/a	30
1/4-18 NPT	7060020406	10	12	28	n/a	30
1/2-12 NPT	7060020408	12	12	28	n/a	30
3/4-14 NPT	7060020412	15	12	28	n/a	32
3/4-14 NPT	7060020409	12	15	28	n/a	32
1-11.5	7060020413	12	15	28	n/a	36

*The plugs come standard without a magnet. If you would like a magnet on your plug(s), please request this.
The dust caps come standard without chain. If you want a chain on your plug(s), please request this.*

Femco Compact Plug LB (Large Bore)

Product Specifications



UNF sizes

Thread size	Item number	T	A	B	S	Hex
1/2-20 UNF	7080020354	10	12	28	2	30
1/2-20 UNF	7080020392	12	12	28	2	30
3/4-16 UNF	7080020358	10	12	28	2	30
3/4-16 UNF	7080020359	15	12	28	2	30
7/8-14 UNF	7080020360	10	12	28	2	30
7/8-18 UNF	7080020363	10	12	28	2	30
7/8-20 UNF	7080020364	10	12	28	2	30
1-14 UNF	7080020367	12	15	28	2	32
1 1/8-12 UNF	7080020387	12	15	28	2	32
1 1/16-12 UNF	7080020377	12	15	28	2	32
1 5/16-12 UNF	7080020372	12	15	28	2	32
1 1/2-12 UNF	7080020355	12	15	28	2	46

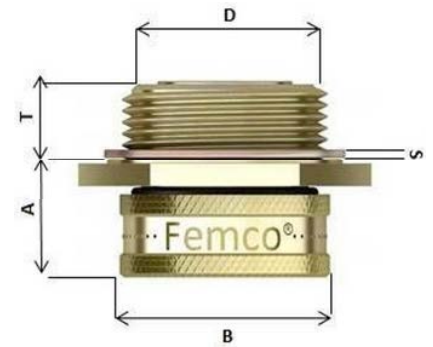

BSP sizes

Thread size	Item number	T	A	B	S	Hex
1/2-14 BSP	7070020397	10	12	28	2	30
3/8-19 BSP	7070020396	10	12	28	2	30
3/4-14 BSP	7070020399	12	15	28	2	32
1-11 BSP	7070020401	12	15	28	2	36

UNS sizes

Thread size	Item number	T	A	B	S	Hex
1-18 UNS	7050020417	12	15	28	2	32

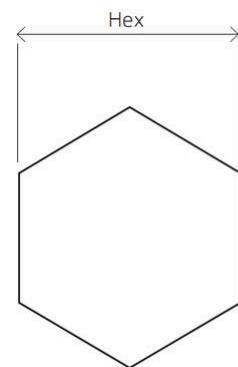

Femco Compact Plug SB (Small Bore)

Product Specifications



Metric sizes

Thread size	Item number	T	A	B	S	Hex
M12x1.25	7090010151	9	12	24	2	22
M12x1.5	7090010152	9	12	24	2	22
M12x1.75	7090010153	9	12	24	2	22
M14x1.25	7090010154	9	12	24	2	22
M14x1.25	7090010157	12	12	24	2	22
M14x1.5	7090010156	9	12	24	2	22
M16x1.5	7090010161	9	12	24	2	22
M18x1.5	7090010163	10	12	24	2	24
M18x1.5	7090010166	14	23	24	2	24
M20x1.5	7090010167	10	12	24	2	27
M22x1.5	7090010172	10	12	24	2	27
M22x1.5	7090010174	15	12	24	2	27

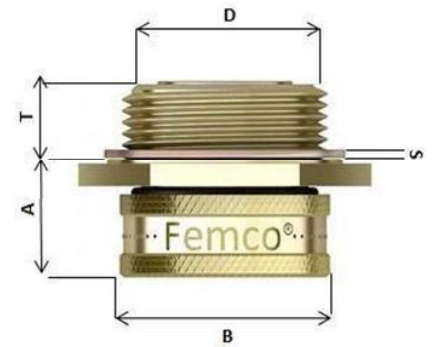

NPT sizes

Thread size	Item number	T	A	B	S	Hex
1/4-18 NPT	7060010350	9	12	24	n/a	22
3/8-18 NPT	7060010352	9	12	24	n/a	24
1/2-14 NPT	7060010353	9	12	24	n/a	27
1/2-14 NPT	7060010354	12	12	24	n/a	27

UNF sizes

Thread size	Item number	T	A	B	S	Hex
1/2-20 UNF	7080010334	9	12	24	2	22
1/2-20 UNF	7080010332	12	12	24	2	22
3/4-16 UNF	7080010339	10	12	24	2	24
3/4-16 UNF	7080010340	15	12	24	2	24

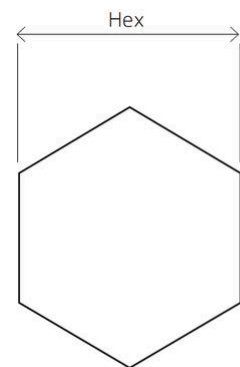

BSP sizes

Thread size	Item number	T	A	B	S	Hex
1/4-19 BSP	7070010346	9	12	24	2	22
3/8-19 BSP	7070010347	9	12	24	2	22
1/2-14 BSP	7070010348	10	12	24	2	27

Femco Compact Accessories

Product Specifications

All Compact **SB** accessories fit all Compact **SB** plugs

All Compact **LB** accessories fit all Compact **LB** plugs

Straight Compact Drainer SB/LB

Description	LB/SB	Thread Size	A	B	C	D	Item Number
Straight Drainer	SB	M20x1.5	25	19	24	15	750003
Straight Drainer with hose 25cm							750001
Straight Drainer with hose 130cm							750002
Straight Drainer	LB	M24x1.25	30	20	28	19	750007
Straight Drainer with hose 25cm							750005
Straight Drainer with hose 130cm							750006

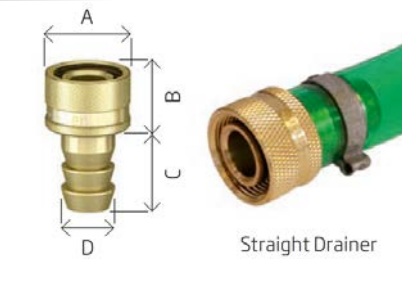

Angled Compact Drainer 45° SB/LB

Description	LB/SB	Thread Size	A	B	C	Item Number
Angled drainer 45°	SB	M20x1.5	25	65	19	750040
Angled drainer 45° with hose 25cm						750024
Angled drainer 45° with hose 130cm						750041
Angled drainer 45°	LB	M24x1.25	30	65	19	750026
Angled drainer 45° with hose 25cm						750013
Angled drainer 45° with hose 130cm						750014

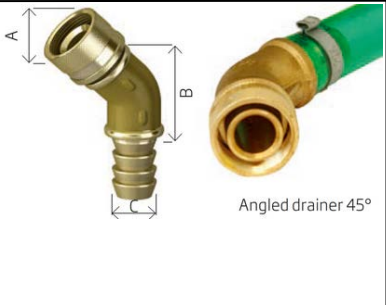

Angled Compact Drainer 90° SB/LB

Description	LB/SB	Thread Size	A	B	C	D	E	Item Number
Angled drainer 90°	SB	M22x1.5	25	17	37	34	15	650119
Angled drainer 90° with hose 25cm								650106
Angled drainer 90° with hose 130cm								650107
Angled drainer 90°	LB	M26x1.5	30	20	40	37	19	650120
Angled drainer 90° with hose 25cm								650108
Angled drainer 90° with hose 130cm								650109

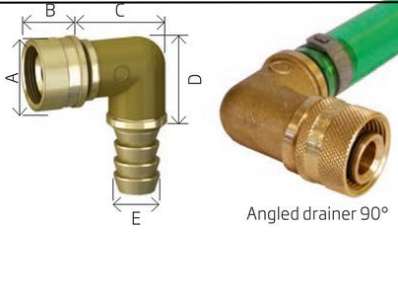

Femco Compact Accessories

Product Specifications

All compact **SB** accessories fit all compact **SB** plugs

All compact **LB** accessories fit all compact **LB** plugs

Compact SB Drainer to Click Drain or Non-Drip

Description	LB/SB	Item Number	
Straight Compact SB to Non-Drip adaptor with 25cm hose	SB	750049	
90° Compact SB to Non-Drip adaptor with 25cm hose	SB	750051	

Other Accessories

Description	LB/SB	Item Number	
Straight compact drainer to 3/4 NPT-male	SB	650128	
	LB	650134	

Description	LB/SB	Item Number	
Dustcap compact	SB	750027	
	LB	750028	

Description	LB/SB	Item Number	
Compact sampling nipple	SB	951009	
	LB	951008	

Femco Click Drain Plug



The Click Drain is the fastest solution for fluid draining. This system consists of an oil drain plug and a quick connect coupler (Clicker). When it's time for an oil change simply click the Femco Clicker onto the oil drain plug. This opens the internal valve, allowing the oil to flow out. Femco's double clicker comes with a built in non-return valve, making it the ultimate solution for draining fluid with a pump or evacuation unit. With the full set up, most trucks can be fully drained of oil in 10-30 seconds. Our Click drain plug is machined from solid brass, a durable, corrosion resistant metal, not prone to conducting heat. The oil drain plug features a dust cover and a two O-ring's, protecting the valve assembly and ensuring reliable performance in the most demanding conditions. There is no need to use heavy wrenches or keys with our plugs.

How it works:

Install the Femco Click plug in your engines oil pan. When it's time for an oil change, simply unscrew the dust cap and click on the Femco Clicker to begin draining. This system works great for gravity drain and for use with waste oil pumps and evacuation units.

When should you choose the Click Drain plug?

- The Click drain is perfect for companies that perform maintenance on a large volume of vehicles or equipment.
- It's easy compatibility with suction units makes it ideal for mobile service.
- The Click drain is not typically used for personal vehicles.

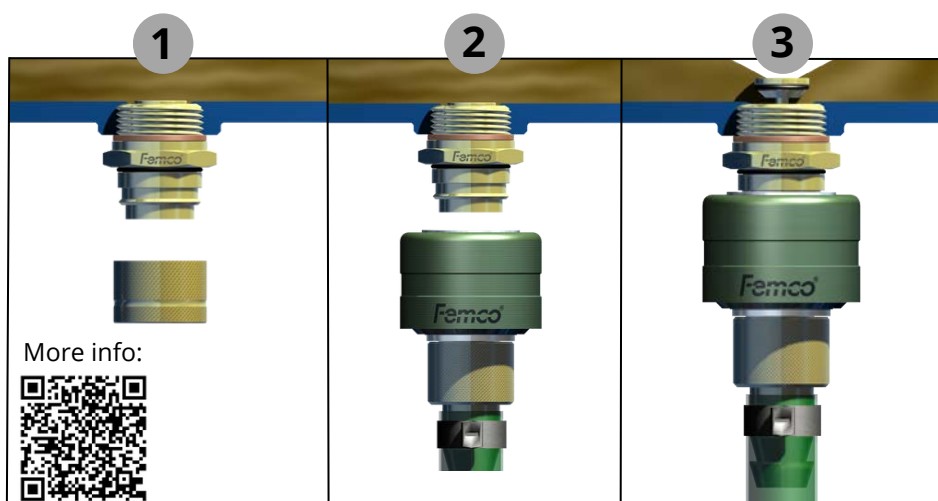

Femco Click Drain Plug LB (Large Bore)

Product Specifications



Metric sizes

Thread size	Item number	T	A	B	S	Hex
M12x1.25	8090020419	10	32	30	2	30
M12x1.5	8090020420	10	32	30	2	30
M12x1.75	8090020421	10	32	30	2	30
M14x1.25	8090020422	10	32	30	2	30
M14x1.5	8090020423	10	32	30	2	30
M16x1.5	8090020426	10	32	30	2	30
M18x1.5	8090020428	10	32	30	2	30
M18x1.5	8090020476	12	30	30	2	30
M18x1.5	8090020477	14	27	30	2	30
M20x1.5	8090020432	15	32	30	2	30
M20x1.5	8090020430	10	32	30	2	30
M22x1.5	8090020436	10	32	30	2	30
M22x1.5	8090020437	14	32	30	2	30
M22x1.5	8090020440	15	32	30	2	30
M24x1.5	8090020444	12	30	30	2	30
M24x1.5	8090020445	15	27	30	2	30
M24x1.5	8090020448	10	42	30	2	30
M24x2.0	8090020447	12	30	30	2	30
M25x1.5	8090020451	15	27	30	2	32
M26x1.5	8090020452	10	30	30	2	32
M26x1.5 50L	8090020455	10	45	30	2	32
M27x2.0	8090020458	12	32	30	2	32
M27x2.0 o-ring	8090020459	12	32	30	o-ring	32
M30x1.5	8090020463	10	32	30	2	36
M32x1.5	8090020467	12	30	30	2	36
M36x2.0	8090020471	12	30	30	2	42
M42x2.0	8090020469	12	30	30	2	50

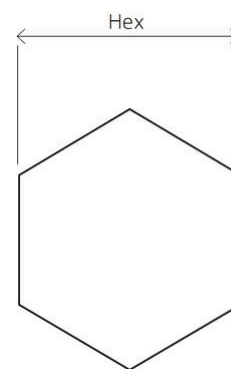
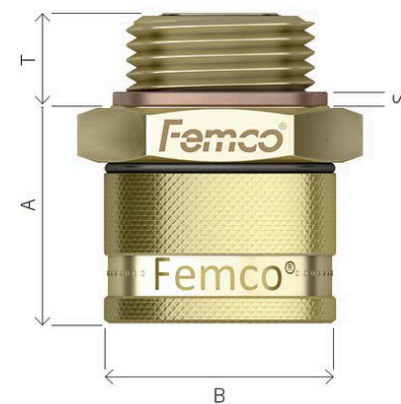

NPT sizes

Thread size	Item number	T	A	B	S	Hex
3/8-18 NPT	8060020512	10	32	30	n/a	30
1/4-18 NPT	8060020511	10	32	30	n/a	30
1/2-14 NPT	8060020513	12	32	30	n/a	30
3/4-14 NPT	8060020514	12	30	30	n/a	32
3/4-14 NPT	8060020520	15	30	30	n/a	32
1 11.5-NPT	8060020516	12	27	30	n/a	36

Femco Click Drain Plug LB (Large Bore)

Product Specifications



UNF sizes

Thread size	Item number	T	A	B	S	Hex
1/2-20 UNF	8080020477	10	32	30	2	30
1/2-20 UNF	8080020512	12	32	30	2	30
3/4-16 UNF	8080020481	10	30	30	2	30
3/4-16 UNF	8080020482	15	32	30	2	30
7/8-14 UNF	8080020483	10	32	30	2	30
7/8-18 UNF	8080020486	10	32	30	2	30
7/8-20 UNF	8080020487	10	32	30	2	30
1-14 UNF	8080020489	12	32	30	2	32
1 1/16-12 UNF	8080020490	15	27	30	2	32
1 1/8-12 UNF	8080020498	12	32	30	2	36
1 1/8-12 UNF	8080020491	15	27	30	2	36
1 5/16-12 UNF	8080020494	12	30	30	2	36
1 1/2-12 UNF	8080020496	12	30	30	2	46

BSP sizes

Thread size	Item number	T	A	B	S	Hex
3/8-19 BSP	8080020501	10	32	30	2	30
1/2-14 BSP	8080020502	10	32	30	2	30
3/4-14 BSP	8080020505	12	32	30	2	32
1-11 BSP	8080020506	12	30	30	2	36

UNS sizes

Thread size	Item number	T	A	B	S	Hex
1-18 UNS	8060020519	12	30	30	2	32

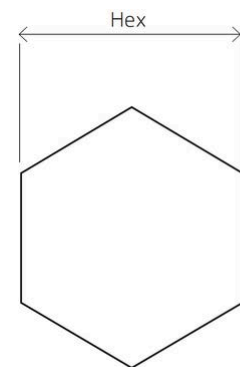
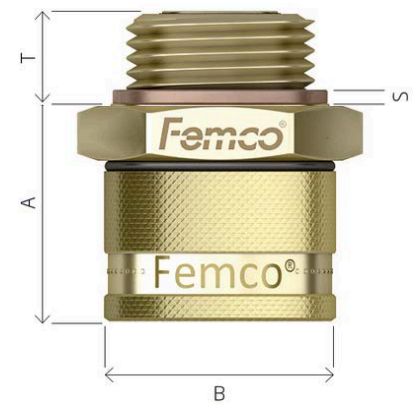





The plugs come standard without a magnet. If you would like a magnet on your plug(s), please request this.
The dust caps come standard without chain. If you want a chain on your plug(s), please request this.

Femco Click Drain Plug LB (Large Bore)

Product Specifications



Special sizes

Thread size	Item number	T	A	B	S	Hex
Special Fit - Hose Connector	6090020087	15	27	30	0	30
						
M12x1.75 - with extended body	6090020130	12	58	30	2	30
						
M22x1.5 (8/7L 42) Stainless Steel Plug with extended body Brass valve and dustcap	8090020439SS	10	37	30	2	32
						
1 1/16"-12-UNF Stainless Steel fuel tank plug POM dustcap	8080020490R	27	27	35	2	32
						
Special Fit - Aluminum plug for MX13 composite oil pan	8040020001					
Special Fit - Ford composite oil pan	8040020009					

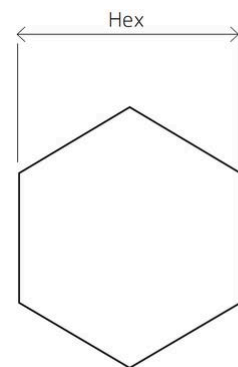
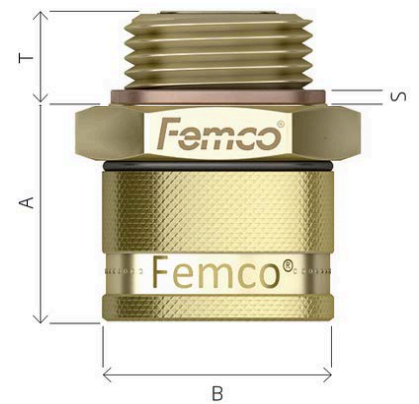

*The plugs come standard without a magnet. If you would like a magnet on your plug(s), please request this.
The dust caps come standard without chain. If you want a chain on your plug(s), please request this.*



Femco Click Drain Accessories

Product Specifications

All Click Drain **LB** accessories fit all Click Drain **LB** plugs

Solo Clicker

Double Clicker

Description	Item Number		Description	Item Number
Straight	840001		Straight	840010
Straight + 25cm hose	840002		Straight + 25cm hose	840011
Straight + 130cm hose	840003		Straight + 130cm hose	840012
Angled 90°	840004		Angled 90°	840013
Angled 90° + 25cm hose	840005		Angled 90° + 25cm hose	840014
Angled 90° + 130cm hose	840006		Angled 90° + 130cm hose	840015
Angled 45°	840007		Angled 45°	840016
Angled 45° + 25cm hose	840008		Angled 45° + 25cm hose	840017
Angled 45° + 130cm hose	840009		Angled 45° + 130cm hose	840018

Solo clicker

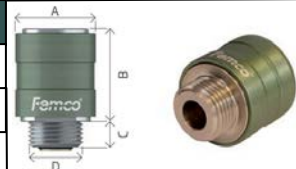
Description	A	B	C	D	Item Number	
Solo Clicker 1/2" BSP	49	37	12	1/2" BSP	851000	
Solo Clicker 1/2" NPT	49	37	12	1/2" NPT	851029	

Double clicker

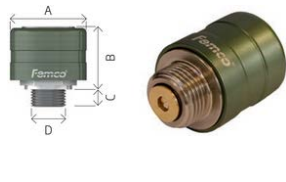
Description	A	B	C	D	Item Number	
Double Clicker 3/4" BSP	49	37	12	3/4" BSP	851013	
Double Clicker 1/2" BSP				1/2" BSP	851017	
Double Clicker 1" BSP				1" BSP	851019	
Double Clicker 3/4" NPT				3/4" NPT	851018	
Double Clicker 1/2" NPT				1/2" NPT	851028	

Double clicker

Description	Item Number	
Angled drainer 90° to 3/4" NPT-female, with valve	840037	
Straight clicker to 3/4" female, with valve	840038	
Angled clicker 45° to 3/4" NPT-female	840039	

Sealing cap

Description	Item Number	
Sealing cap For Clicker	851000	

Femco Non-Drip Plug



Femco's Non-Drip series of fittings and couplers are the cleanest solution for heavy duty truck and equipment maintenance. The Non-Drip utilizes a dry break connection between the drain plug and the coupler (Clicker) to ensure that not a single drop of fluid is exposed or spilled during the draining or filling process. To accelerate the draining or filling process further, the Non-Drip can be used in combination with a EVAC unit or oil pump.

Non-drip plugs are the perfect solution to prevent spills during maintenance. The fully sealed system, with valves in both the plug and coupler, achieves the most efficient, safe, and clean oil changes. With the ability to change fluids without any leftover residue, maintenance teams can safely service their vehicles and equipment in the field.

How it works:

Install the Femco Non-Drip plug in your engines oil pan. When it's time for an oil change, simply unscrew the dust cap and click on the Non-Drip Clicker to begin draining. This system is best when paired with an oil evacuation unit or pump.

When should you choose the Non-Drip plug?

- Excellent for field service, or service of particularly dangerous or dirty fluids.
- Perfect for both draining and filling fluid.
- No drips, spills, or residual fluid on either end of the connection.
- Due to the design, the Non-Drip is only available for applications with drain ports of 18mm or larger.

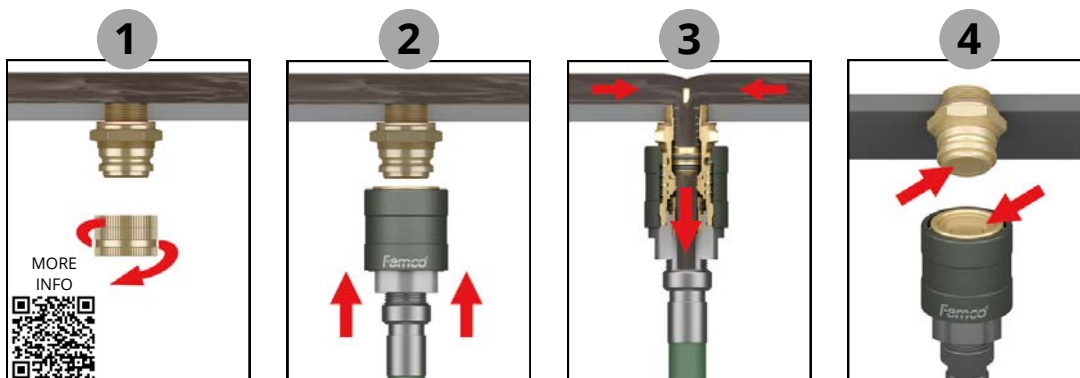

While connecting or disconnecting the drainer, there is **not a drop of oil spilled.**

Femco Non-Drip Plug LB (Large Bore)

Product Specifications



Metric sizes

Thread size	Item number	T	A	B	S	Hex
M22x1.5	9090020046	10	27	30	2	30
M24x1.5	9090020053	10	27	30	2	30
M27x2.0	9090020070	10	27	30	2	30
M27x2.0 + o-ring	9090020071	10	27	30	0-ring	30

NPT sizes

Thread size	Item number	T	A	B	S	Hex
1 11.5-NPT	9060020145	10	27	30	n/a	36

UNF sizes

Thread size	Item number	T	A	B	S	Hex
1 1/8-12 UNF	9080020124	10	27	30	2	36

UNS sizes

Thread size	Item number	T	A	B	S	Hex
1-18 UNS	9060020148	10	27	30	2	32

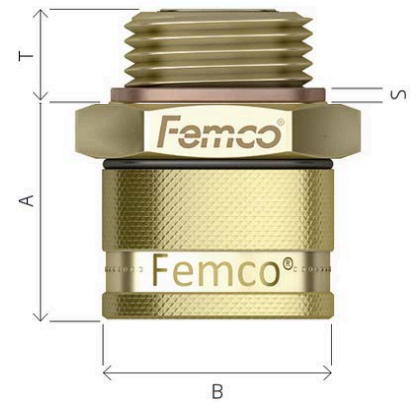

Non-Drip LB Clicker

Description	Item Number
Non Drip Clicker 1/2" BSP	940000
Non Drip Clicker 3/4" BSP	940001
Non Drip Clicker 1" BSP	940002
Non Drip Clicker 1/2" NPT	940003
Non Drip Clicker 3/4" NPT	940004
Non Drip Clicker 1" NPT	940005
Non Drip Clicker - ESOC Connection	940007

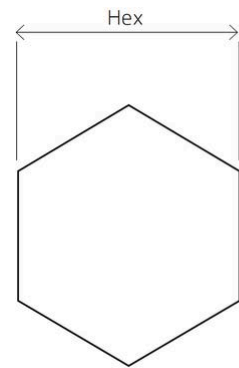
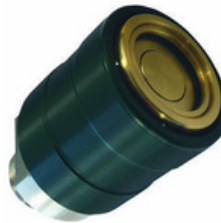

Non-drip drain plugs are not available with a magnet.

The dust caps come standard without chain. If you want a chain on your plug(s), please request this.

Femco XL Plug



Femco's XL drain plug is the largest option in our lineup. This highly specialized system is designed to maximize flow rate for applications with an exceptionally large volume of fluid. Like our other products, the XL is machined from solid brass, a corrosion resistant material not prone to conducting heat.

Femco XL Drain plugs are not suitable for most vehicles or equipment. **The XL plug is ideal for drain ports 30mm and larger.**

To service fleets of large vehicles and equipment, Femco® has also introduced the XL Click Drain. This quick-coupling system combines the advantages of the XL and the Click Drain plugs. This is ideal for servicing locomotives and mining equipment with an oil evacuation unit or pump.

If you would like more information about the XL plug, please feel free to contact us. Our experienced customer care team is always available to discuss your needs and help determine if the XL plug is a suitable solution.

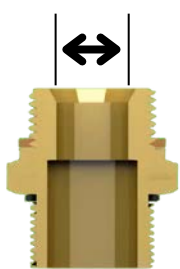

Standard

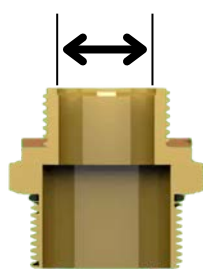

XL



More Info

Plugs for EV's



Femco Plugs For EV's

Across heavy equipment, construction, mining, public transit, and trucking, developing practical, easy to service EVs is a priority for many of our OEM clients. As part of an ever evolving industry, Femco is at the forefront of developing new drain solutions to fit these needs. In line with our commitment to global OEMs, Femco has worked to develop several light-weight aluminum alloy drain valves for EV fluid applications. We're aware that weight savings and durability are of utmost importance, and have made sure to deliver a high quality solution. With in-house engineering and production capabilities, we can create specialized drain valves from a wide variety of materials to suit ever evolving industry needs.

Femco's EV valves have proven invaluable for use on EV coolant systems, differential fluid, and many more applications. For custom parts, please feel free to contact us. Together we will design and produce a suitable solution for your needs.

We work with many OEMs in different industries across the world. We adhere to the highest quality standards to ensure we only deliver the finest of finished products. Quality checks are conducted meticulously throughout the entire process, both during and after production.

Special Parts



Femco Special Parts

Femco has an extensive portfolio for the manufacturing of specialized and custom parts. We work with our customers to produce tailor made solutions for unique problems. We're able to achieve this with help of our in-house CNC machine park (specialized CNC machines), professional team of engineers, and 40+ years of industry experience.

We specialize in milling and turning materials such as brass, aluminum, stainless steel and plastics (POM-C) (PVC). We strive to provide the highest quality parts to our customers. We have implemented Statistical Process Control (SPC), Production Part Approval Process (PPAP) and several other quality standards to ensure the quality of our products. This has resulted in ISO 9001 and TUV certification.

With a wide range of OEM customers in different industries, we're well versed in both meeting and exceeding the highest standards. We handle the entire production process from raw material to finished product. By keeping this entire process in-house, we're able to move quickly with the production of samples, prototypes, and free quotations.

Feel free to reach out to us for your special parts requirements. We embrace challenges and in collaboration with you, strive to deliver high-quality solutions. Our team is ready to assist you in the development or design of parts, offering unique insight tailored to your project.

Why choose Femco?

- In-House engineering and manufacturing.
- Over 40 years of experience.
- Specialist in custom-designed products.
- High standards on quality.



Welcome to Femco, where precision meets customization, and collaboration results in solutions engineered with utmost proficiency.



*Empowering Progress, Engineering Excellence -
Femco Draintechnology
Where innovation meets efficiency.*

Your journey to superior drainage solutions begins here.





Femco USA Inc.

22722 29th Dr SE, Suite 100

Bothell WA 98021

United States

 +1 425 318 6050

 +1 800 340 2147

 usa@femco.com

Femco Drain Technology B.V.

Rendementsweg 7

3641 SK Mijdrecht

The Netherlands

 +31 (0)297 - 23 02 05

 info@femco.com